

INSTRUCTION MANUAL WIFI DONGLE FOR SOLAR INVERTER



INTRODUCTION

Thank you for selecting and buying V-TAC Product. V-TAC will serve you the best. Please read these instructions carefully & keep this user manual handy for future reference. If you have any another query, please contact our dealer or local vendor from whom you have purchased the product. They are trained and ready to serve you at the best.



Multi-Language Manual QR CODE

Please scan the QR code to access the manual in multiple languages.

WARNING

1. Please make sure to turn off the power before starting the installation.
2. Installation must be performed by a qualified electrician.



This marking indicates that this product should not be disposed of with other household wastes.

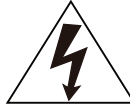

Caution, risk of electric shock.



NOTICE:

Please read this manual carefully before using products and keep it in the place where O&M providers can easily find.

Due to product upgrade and other factors, the content of this manual might change from time to time. Please take actual product as standard and get latest manual from www.solarman.cn or sales. Unless otherwise agreed herein, this manual will only be used as guidance. Any statement, information or suggestion in this manual will not take any form of responsibility.

Without written permission, any content of this document (partly or entirely) cannot be extracted, copied or transmitted in any form by any company or individual.

DOWNLOAD APP



SOLARMAN Smart
for end user



SOLARMAN Business
for business

IOS: Search "SOLARMAN Smart" in Apple Store.

Android: Search "SOLARMAN Smart" in Google Play.

1. Stick Logger Installation

Type 1

Step1: Assemble logger to the inverter communication interface as shown in the diagram.

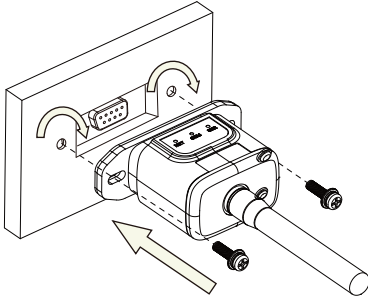

Type 2

Step1: Assemble logger to the inverter communication interface as shown in the diagram.

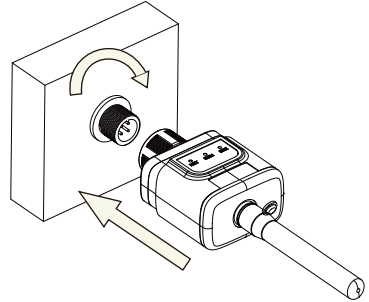

Warning:

Please do not hold the logger body to rotate while install or remove the logger.

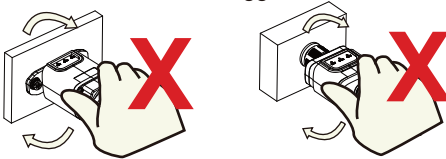

Logger Status

Check Indicator light

Lights	Implication	Status Description(All lights are single green lights.)
NET	Communication with router	1.Light off: Connection to the router failed. 2.On 1s/Off 1s(Slow flash): Connection to the router succeeded. 3.Light keeps on: Connection to the server succeeded. 4.On 100ms/Off 100ms(Fast flash): Distributing network fast.
COM	Communication with inverter	1.Light keeps on: Logger connected to the inverter. 2.Light off: Connection to the inverter failed. 3.On 1s/Off 1s(Slow flash): Communicating with inverter.
READY	Logger running status	1.Light off: Running abnormally. 2.On 1s/Off 1s (Slow flash): Running normally. 3.On 100ms/Off 100ms(Fast flash): Restore factory settings.

The normal operation status of the stick logger, when router connected to the network normally:

- 1.Connection to the server succeeded: NET light keeps on after the logger powered on.
- 2.Logger running normally: READY light flashes.
- 3.Connection to the inverter succeeded: COM light keeps on.

ABNORMAL STATE PROCESSING

If the data on platform is abnormal when the stick logger is running, please check the table below and according to the status of indicator lights to complete a simple troubleshooting. If it still can not be resolved or indicator lights status do not show in the table below, please contact Customer Support. (Note: Please using the following table query after power-on for 2mins at least.)

NET  NET	COM  COM	READY  READY	Fault Description	Fault Cause	Solution
Any state	OFF	Slow flash	Communication with inverter abnormal	1.Connection between stick logger and inverter loosen. 2.Inverter does not match with stick logger's communication rate.	1.Check the connection between stick logger and inverter. Remove the stick logger and install again. 2.Check inverter's communication rate to see if it matches with stick logger's. 3.Long press Reset button for 5s, reboot stick logger.
OFF	ON	Slow flash	Connection between logger and router abnormal	1.Stick logger does not have a network. 2.Antenna abnormal 3.Router WiFi signal strength weak.	1.Check if the wireless network configured. 2.Check the antenna, if there is any damage or loose. 3.Enhance router WiFi signal strength. 4.Long press Resetbutton for 10s, reboot stick logger and networking again.
Slow flash	ON	Slow flash	Connection between logger and router normal, connection between logger and remote server abnormal.	1.Router networking abnormal. 2.The server point of logger is modified. 3.Network limitation, server cannot be connected.	1.Check if the router has access to the network. 2.Check the router's setting, if the connection is limited. 3.Contact our customer service.
OFF	OFF	OFF	Power supply abnormal	1.Connection between stick logger and inverter loosen or abnormal. 2.Inverter power insufficient. 3.Stick Logger abnormal.	1.Check the connection, remove the stick logger and install again. 2.Check inverter output power. 3.Contact our customer service.
Fast flash	Any state	Any state	SMARTLINK networking status	Normal	1.Exit automatically after 5mins. 2.Long press Reset button for 5s, reboot stick logger. 3.Long press Reset button for 10s, restore factory settings.
Any state	Any state	Fast flash	Restore factory settings	Normal	1.Exit automatically after 1mins. 2.Long press Reset button for 5s, reboot stick logger. 3.Long press Reset button for 10s, restore factory settings.

USAGE METHODS AND NOTICES FOR RESET BUTTON

Usage methods and key-press descriptions for Reset button

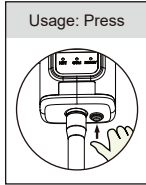

Key-press	Status Description	Light Status
Short press 1s	SMARTLINK rapid networking status.	NET light flashes fast for 100ms.
Long press 5s	Rebooting the stick logger.	All lights are extinguished immediately.
Long press 10s	Resetting the stick logger.	1.All lights are extinguished after 4s. 2.READY light flashes fast for 100ms.

NOTICES FOR RESET BUTTON

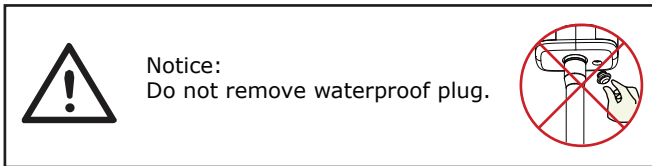

USER MANUAL FOR SOLARMAN SMART APP

1.Registration

Go to SOLARMAN Smart and register. Click "Register" and create your account here.

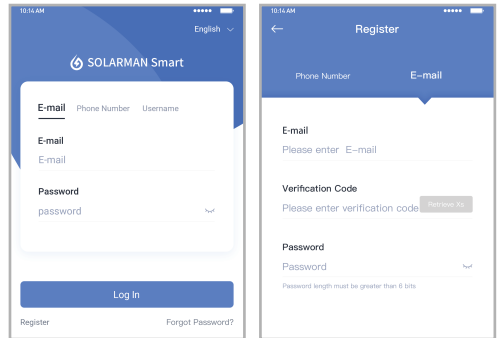

2.Create a Plant

Click "Add Now" to create your plant. Please fill in plant basic info and other info here.

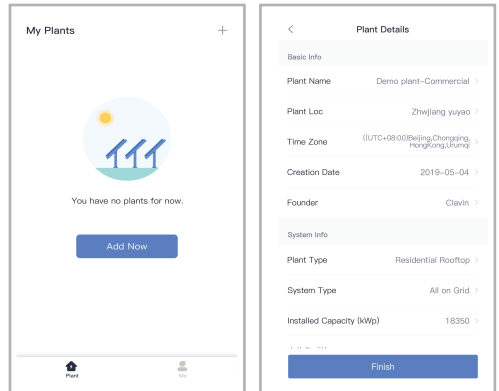

3.Add a Logger

Method 1: Enter logger SN manually.

Method 2: Click the icon in the right and scan to enter logger SN
You can find logger SN in the external packaging or on the logger body.

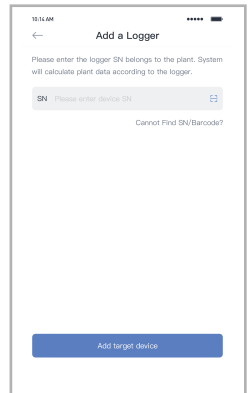
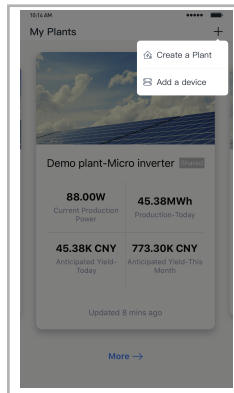

4.Network Configuration

After the logger is added, please configure the network to ensure normal operation.

Go to "Plant Details"->"Device List", find the target SN and click "Networking".

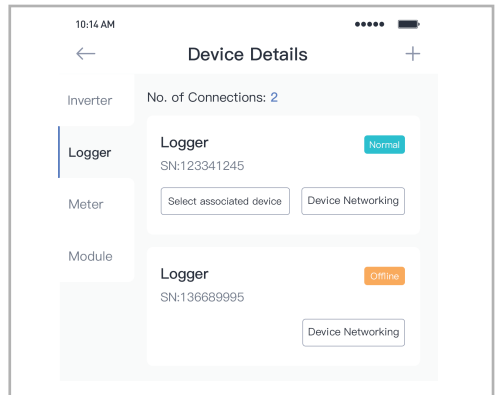

Step 1: Confirm Wi-Fi Info

Please make sure your phone has connected to the right WiFi network. And click "Start".

Notice:

5G WiFi is not supported .

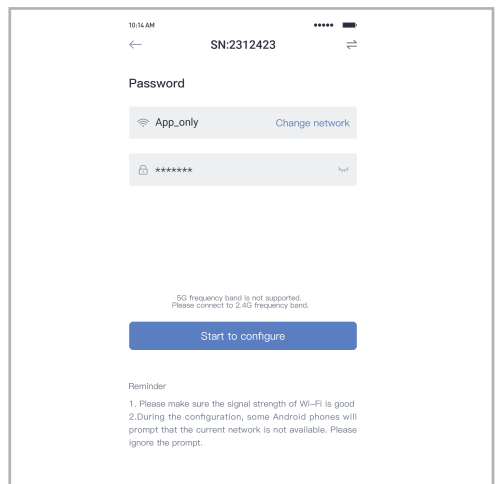

Step 2: Connect to AP network
Click "Go to connect" and find the right "AP_XXXXX" network (XXXXXX Refers to logger SN).

If the password is required, you can find the password on the logger body. Go back to SOLARMAN Smart APP, after connecting to AP network.

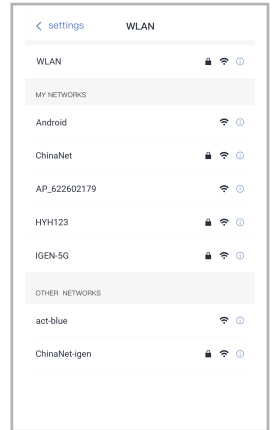
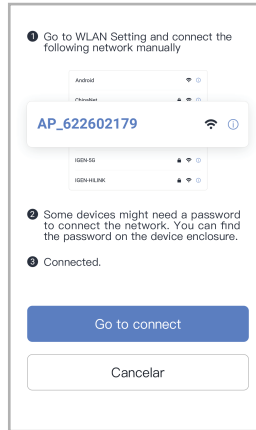

Step 3: Auto Configuration
Please wait for a while to complete the configuration. Then system will switch to the following page.

Click "Done" to check plant data. (Usually, the data will be updated in 10 mins)

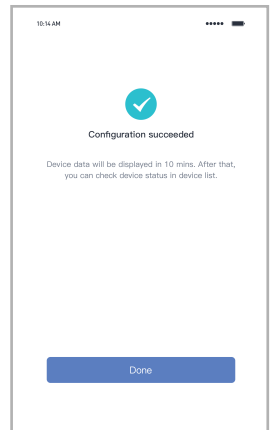
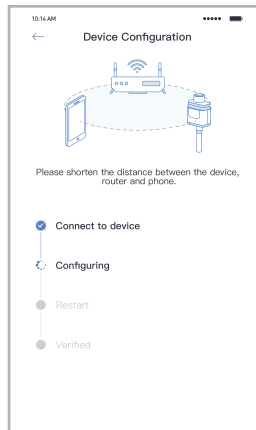

Warning:

Please make sure the stick logger is working properly before you leave the site. If there is anything abnormal, please do not leave the site and contact customer service