



**CE EMC**  
**TEST REPORT**  
For  
**LED MAGNETICTRACK LIGHTS**

**Model No.:** VT-4121, VT-4131, VT-4141, VT-4143, VT-4210, VT-4220, VT-4215, VT-4315

**Applicant :** V-TAC EXPORTS LIMITED  
ROOM NO.301, KAM ON BUILDING 176A QUEENS ROAD CENTRAL,  
CENTRAL, HONGKONG

**Manufacturer :** V-TAC EXPORTS LIMITED  
ROOM NO.301, KAM ON BUILDING 176A QUEENS ROAD CENTRAL,  
CENTRAL, HONGKONG

**Issued By :** Global-Standard Testing Service Co., Ltd.  
Room 1505, Building B, Chuangxin Plaza, Pingshan Avenue, Pingshan  
District, Shenzhen, China

**Tel :** +86 755 33863599

**Email :** [market@gstslab.com](mailto:market@gstslab.com)



**Report Number :** GST.200508.M201E

**Issued Date :** May 13, 2020

**Date of Report :** May 13, 2020

**Note:**

1. The test data and result is based on the tested sample only.
2. Please verify information in the report on GST web: [www.gstslab.com](http://www.gstslab.com) through report number.
3. All rights reserve, the pirate edition investigates necessarily! This report shall not be reproduced unless under the authority of Global-Standard Testing Service Co., Ltd.

## TABLE OF CONTENTS

<b>1. TEST CERTIFICATION</b> .....	<b>4</b>
<b>2. TEST RESULT SUMMARY</b> .....	<b>5</b>
<b>3. EUT DESCRIPTION</b> .....	<b>6</b>
<b>5. TEST METHODOLOGY</b> .....	<b>8</b>
5.1. DECISION OF FINAL TEST MODE.....	8
5.2. EUT SYSTEM OPERATION.....	8
<b>6. SETUP OF EQUIPMENT UNDER TEST</b> .....	<b>9</b>
6.1. DESCRIPTION OF SUPPORT UNITS.....	9
6.2. CONFIGURATION OF SYSTEM UNDER TEST.....	9
<b>7. FACILITIES AND ACCREDITATIONS</b> .....	<b>10</b>
7.1. FACILITIES.....	10
7.2. ACCREDITATIONS.....	10
7.3. MEASUREMENT UNCERTAINTY.....	10
<b>8. EMISSION TEST</b> .....	<b>11</b>
8.1. CONDUCTED EMISSION MEASUREMENT.....	11
8.1.1. LIMITS.....	11
8.1.2. TEST PROCEDURES.....	11
8.1.3. TEST SETUP.....	12
8.1.4. TEST RESULTS.....	12
8.2. RADIATED ELECTROMAGNETIC DISTURBANCE.....	15
8.2.1. LIMITS.....	15
8.2.2. TEST PROCEDURE.....	15
8.2.3. TEST SETUP.....	16
8.2.4. TEST RESULTS.....	16
8.3. RADIATED EMISSION MEASUREMENT.....	20
8.3.1. LIMITS.....	20
8.3.2. TEST PROCEDURE.....	20
8.3.3. TEST SETUP.....	21
8.3.4. TEST RESULTS.....	21
8.4. HARMONICS CURRENT MEASUREMENT.....	24
8.4.1. LIMITS OF HARMONICS CURRENT MEASUREMENT.....	24
8.4.2. TEST PROCEDURE.....	24
8.4.3. TEST SETUP.....	25
8.4.4. TEST RESULTS.....	25
8.5. VOLTAGE FLUCTUATION AND FLICKS MEASUREMENT.....	32
8.5.1. LIMITS OF VOLTAGE FLUCTUATION AND FLICKS MEASUREMENT.....	32
8.5.2. TEST PROCEDURE.....	32
8.5.3. TEST SETUP.....	32
8.5.4. TEST RESULTS.....	33
<b>9. IMMUNITY TEST</b> .....	<b>34</b>
9.1. GENERAL DESCRIPTION.....	34
9.2. GENERAL PERFORMANCE CRITERIA DESCRIPTION.....	35
9.3. ELECTROSTATIC DISCHARGE (ESD).....	35
9.3.1. TEST SPECIFICATION.....	35

9.3.2. TEST PROCEDURE.....	36
9.3.3. TEST SETUP.....	37
9.3.4. TEST RESULTS.....	38
<b>9.4. RADIATED, RADIO-FREQUENCY, ELECTROMAGNETIC FIELD (RS).....</b>	<b>39</b>
9.4.1. TEST SPECIFICATION.....	39
9.4.2. TEST PROCEDURE.....	39
9.4.3. TEST SETUP.....	40
9.4.4. TEST RESULTS.....	41
<b>9.5. ELECTRICAL FAST TRANSIENT (EFT).....</b>	<b>42</b>
9.5.1. TEST SPECIFICATION.....	42
9.5.2. TEST PROCEDURE.....	42
9.5.3. TEST SETUP.....	43
9.5.4. TEST RESULTS.....	44
<b>9.6. SURGE IMMUNITY TEST.....</b>	<b>45</b>
9.6.1 TEST SPECIFICATION.....	45
9.6.2. TEST PROCEDURE.....	45
9.6.3. TEST SETUP.....	46
9.6.4. TEST RESULTS.....	46
<b>9.7. CONDUCTED RADIO FREQUENCY DISTURBANCES (CS).....</b>	<b>47</b>
9.7.1. TEST SPECIFICATION.....	47
9.7.2. TEST PROCEDURE.....	47
9.7.3. TEST SETUP.....	48
9.7.4. TEST RESULTS.....	48
<b>9.8. POWER FREQUENCY MAGNETIC FIELD.....</b>	<b>49</b>
9.8.1. TEST SPECIFICATION.....	49
9.8.2. TEST PROCEDURE.....	49
9.8.3. TEST SETUP.....	50
9.8.4. TEST RESULTS.....	51
<b>9.9. VOLTAGE DIP &amp; VOLTAGE INTERRUPTIONS.....</b>	<b>51</b>
9.9.1. TEST SPECIFICATION.....	51
9.9.2. TEST PROCEDURE.....	52
9.9.3. TEST SETUP.....	52
9.9.4. TEST RESULTS.....	53
<b>10. TEST SETUP PHOTOGRAPHS.....</b>	<b>54</b>
<b>11. PHOTOGRAPHS OF EUT.....</b>	<b>55</b>

# 1. TEST CERTIFICATION

<b>Product:</b>	LED MAGNETICTRACK LIGHTS
<b>Model:</b>	VT-4121, VT-4131, VT-4141, VT-4143, VT-4210, VT-4220, VT-4215, VT-4315
<b>Applicant:</b>	V-TAC EXPORTS LIMITED ROOM NO.301, KAM ON BUILDING 176A QUEENS ROAD CENTRAL, CENTRAL, HONGKONG
<b>Factory:</b>	V-TAC EXPORTS LIMITED ROOM NO.301, KAM ON BUILDING 176A QUEENS ROAD CENTRAL, CENTRAL, HONGKONG
<b>Test Voltage:</b>	DC 24V
<b>Applicable Standards:</b>	EN 55015: 2013+A1:2015 EN 61547: 2009 EN 61000-3-2:2014 EN 61000-3-3: 2013+A1:2019

Deviation from Applicable Standard
None

The above equipment has been tested by Global-Standard Testing Service Co., Ltd. and found compliance with the requirements set forth in the technical standards mentioned above. The results of testing in this report apply only to the product/system, which was tested. Other similar equipment will not necessarily produce the same results due to production tolerance and measurement uncertainties.

**Tested By:** John Huang **Date:** May 10, 2020  
**Approved By:** Nico Xie **Date:** May 13, 2020



## 2. TEST RESULT SUMMARY

EMISSION			
Standard	Item	Result	Remarks
EN 55015:2013+A1:2015	Conducted (Main Port)	PASS	Meet limit
	Radiated Electromagnetic Disturbance	PASS	Meet limit
	Radiated	PASS	Meet limit
EN 61000-3-2:2014	Harmonic current emissions	PASS	Meet limit
EN 61000-3-3:2013+A1:2019	Voltage fluctuations & flicker	PASS	Meet limit

IMMUNITY 【EN 61547:2009】			
Standard	Item	Result	Remarks
EN 61000-4-2:2009	ESD	PASS	Meets the requirements of Performance Criterion B
EN 61000-4-3:2006+A1:2008+A2:2010	RS	PASS	Meets the requirements of Performance Criterion A
EN 61000-4-4:2012	EFT	PASS	Meets the requirements of Performance Criterion B
EN 61000-4-5:2014	Surge	PASS	Meets the requirements of Performance Criterion B
EN 61000-4-6:2014	CS	PASS	Meets the requirements of Performance Criterion A
EN 61000-4-8: 2010	PFMF	PASS	Meets the requirements
EN 61000-4-11:2004	Voltage dips & voltage variations	PASS	Meets the requirements of <b>Voltage dips and variations</b> 1) 30% reduction performance Criterion C 2) 100% reduction performance Criterion B

- Note:**
1. The test result judgment is decided by the limit of test standard
  2. The information of measurement uncertainty is available upon the customer's request.

### 3. EUT DESCRIPTION

<b>Product</b>	LED MAGNETIC TRACK LIGHTS
<b>Model</b>	VT-4121
<b>Applicant</b>	V-TAC EXPORTS LIMITED
<b>Housing material</b>	Plastic&Metal
<b>EUT Type</b>	<input checked="" type="checkbox"/> Engineering Sample. <input type="checkbox"/> Product Sample, <input type="checkbox"/> Mass Product Sample.
<b>Serial Number</b>	N/A
<b>EUT Power Rating</b>	DC24V, 0.9A, 20W
<b>AC Line</b>	N/A

## 4. TEST INSTRUMENTS

Immunity shielded room				
Name of Equipment	Manufacturer	Model	Serial Number	Calibration Due
EMC PARTNER TRANSIENT 2000	EMC PARTNER	TRA2000	881	09/27/2020
Power-frequency Magnetic field	SCHAFFNER	CCN 1000-1	72046	09/27/2020
Induction Coil Interface	SCHAFFNER	INA2141	6003	09/27/2020
Signal Generator	Maconi	2022D	119246/003	09/27/2020
Power Amplifier	M2S	A00181-1000	9801-112	09/27/2020
CDN	MEB	M3-8016	003683	09/27/2020
Power Amplifier	M2S	AC8113/ 800-250A	9801-179	09/27/2020
Power Antenna	SCHAFFNER	CBL6140A	1204	09/27/2020
ESD 2000	EMC PARTNER	ESD2000	182	09/27/2020
Harmonic & Flicker Tester	California instruments	PACS-3	SB2588/01	09/27/2020
AC Power Source	California instruments	5001iX-CTS-40	SB2588	09/27/2020
EMI Test Receiver	R&S	ESCI	100005	09/27/2020
Spectrum Analyzer	R&S	FSU	100114	09/27/2020
Pre Amplifier	H.P.	HP8447E	2945A02715	09/27/2020
Bilog Antenna	SUNOL Sciences	JB3	A021907	09/27/2020
Cable	TIME MICROWAVE	LMR-400	N-TYPE04	09/27/2020
System-Controller	CCS	N/A	N/A	N.C.R
Turn Table	CCS	N/A	N/A	N.C.R
Antenna Tower	CCS	N/A	N/A	N.C.R
Triple-Loop Antenna	EVERFINE	LLA-2	N/A	09/27/2020
LISN	AFJ	LS16	16010222119	09/27/2020
LISN(EUT)	Mestec	AN3016	04/10040	09/27/2020

**NOTE:**

- (1) The calibration interval of the above test instruments is 12 months and the calibrations are traceable to international system unit (SI).
- (2). N.C.R = No Calibration Request.

## 5. TEST METHODOLOGY

### 5.1. DECISION OF FINAL TEST MODE

The EUT was tested together with the thereafter additional components, and a configuration, which produced the worst emission levels, was selected and recorded in this report.

The following test mode(s) were scanned during the preliminary test:

Pre-Test Mode		
Emission	Conducted Emission	Mode: Normal Operating
	Radiated Electromagnetic Disturbance	Mode: Normal Operating
	Radiated Emission	Mode: Normal Operating
Immunity		Mode: Normal Operating

After the preliminary scan, the following test mode was found to produce the highest emission level.

Pre-Test Mode		
Emission	Conducted Emission	Mode: Normal Operating
	Radiated Electromagnetic Disturbance	Mode: Normal Operating
	Radiated Emission	Mode: Normal Operating
Immunity		Mode: Normal Operating

### 5.2. EUT SYSTEM OPERATION

1. Set up EUT with the support equipments.
2. Make sure the EUT work normally during the test.



## 6. SETUP OF EQUIPMENT UNDER TEST

### 6.1. DESCRIPTION OF SUPPORT UNITS

The EUT has been tested as an independent unit together with other necessary accessories or support units. The following support units or accessories were used to form a representative test configuration during the tests.

No.	Equipment	Model No.	Serial No.	FCC ID	Trade Name	Data Cable	Power Cord
1.	N/A	N/A	N/A	N/A	N/A	N/A	N/A

**Note:**

- 1) All the equipment/cables were placed in the worst-case configuration to maximize the emission during the test.
- 2) Grounding was established in accordance with the manufacturer's requirements and conditions for the intended use.

### 6.2. CONFIGURATION OF SYSTEM UNDER TEST

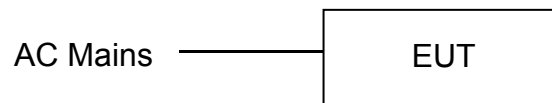

(EUT: LED MAGNETICTRACK LIGHTS )

## 7. FACILITIES AND ACCREDITATIONS

### 7.1. FACILITIES

The sites are constructed in conformance with the requirements of ANSI C63.4 and CISPR Publication 15. All receiving equipment conforms to CISPR Publication 16-1, "Radio Interference Measuring Apparatus and Measurement Methods."

All measurement required was performed at laboratory of SEM Testing Technology Co., Ltd. 1/F, Building A, Hongwei Industrial Park, Liuxian 2nd Road, Bao'an District, Shenzhen, P.R.C.

### 7.2. ACCREDITATIONS

### 7.3. MEASUREMENT UNCERTAINTY

Where relevant, the following measurement uncertainty levels have been estimated for tests performed on the EUT as specified in CISPR 16-4-2:

Measurement	Frequency	Uncertainty	
Conducted emissions	9kHz~30MHz	+/- 3.59dB	
Radiated electromagnetic	9kHz~30MHz	+/- 4.77dB	
Radiated emissions	Horizontal	30MHz ~ 200MHz	+/- 4.77dB
		200MHz ~1000MHz	+/- 4.93dB
	Vertical	30MHz ~ 200MHz	+/- 5.04dB
		200MHz ~1000MHz	+/- 4.93dB

This uncertainty represents an expanded uncertainty expressed at approximately the 95% confidence level using a coverage factor of k=2.

## 8. EMISSION TEST

### 8.1. CONDUCTED EMISSION MEASUREMENT

#### 8.1.1. LIMITS

FREQUENCY (MHz)	LIMITS(dBuV)	
	Quasi-peak	Average
0.009-0.05	110	N/A
0.05-0.15	90 – 80	N/A
0.15 – 0.5	66 – 56	56 – 46
0.50 – 5.0	56	46
5.0 – 30.0	60	50

**NOTE:**

- (1) The lower limit shall apply at the transition frequencies.
- (2) The limit decreases in line with the logarithm of the frequency in the range of 0.15 to 0.50 MHz.
- (3) All emanations from EUT or system, shall not exceed the level of field strengths specified above.

#### 8.1.2. TEST PROCEDURES

##### Procedure of Preliminary Test

The EUT and Support equipment, if needed, was set up as per the test configuration to simulate typical usage per the user's manual. When the EUT is a tabletop system, a wooden table with a height of 0.8 meters is used and is placed on the ground plane. When the EUT is a floor standing equipment, it is placed on the ground plane, which has a 3-12 mm non-conductive covering to insulate the EUT from the ground plane.

The EUT test program was started. Emissions were measured on each current carrying line of the EUT using an EMI Test Receiver connected to the LISN powering the EUT. The Receiver scanned from 9 kHz to 30MHz for emissions in each of the test modes. During the above scans, the emissions were maximized by cable manipulation.

The test mode(s) described in Item 3.1 were scanned during the preliminary test.

After the preliminary scan, we found the test mode described in Item 3.1 producing the highest emission level.

The EUT configuration and cable configuration of the above highest emission levels were recorded for reference of the final test.

##### Procedure of Final Test

EUT and support equipment were set up on the test bench as per the configuration with highest emission level in the preliminary test.

A scan was taken on both power lines, Line 1 and Line 2, recording at least the six highest emissions. Emission frequency and amplitude were recorded into a computer in which correction factors were used to calculate the emission level and compare reading to the applicable limit.

The test data of the worst-case condition(s) was recorded.

### 8.1.3. TEST SETUP

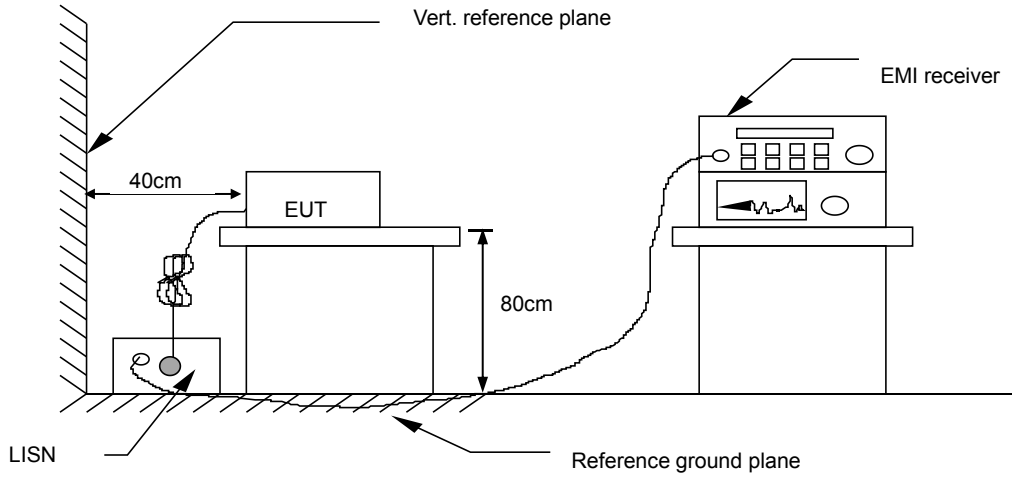

For the actual test configuration, please refer to the related item – Photographs of the Test Configuration.

### 8.1.4. TEST RESULTS

Temperature ( °C )	22~28
Humidity ( %RH )	50~58
Barometric Pressure ( mbar )	950~1000
EUT	LED MAGNETICTRACK LIGHTS
M/N	VT-4121
Operating Mode	Normal Operating
Test Results	PASS

Please refer to following diagram for individual

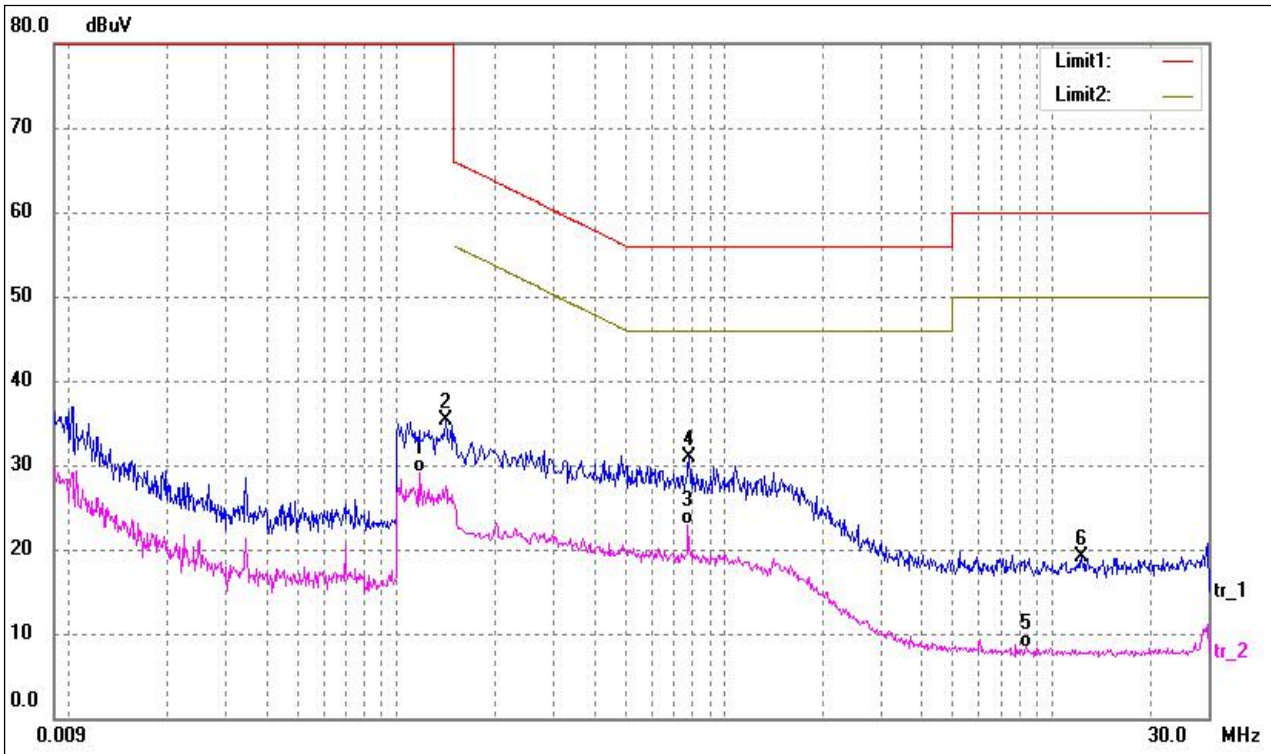

EUT:	LED MAGNETICTRACK LIGHTS	Model Name :	VT-4121
Temperature:	24 °C	Relative Humidity:	54%
Pressure:	1010 hPa	Test Date :	May 10, 2020
Test Mode :	Normal Operating	Polarization :	VCC
Test Power :	DC 24V		

No.	Frequency (MHz)	Reading (dBuV)	Correct (dB/m)	Result (dBuV)	Limit (dBuV)	Margin (dB)	Detector
1	0.1175	28.60	0.46	29.06	58.02	-28.96	AVG
2	0.1416	34.92	0.39	35.31	80.52	-45.21	peak
3*	0.7780	22.76	0.09	22.85	46.00	-23.15	AVG
4	0.7820	30.89	0.09	30.98	56.00	-25.02	peak
5	8.3500	8.30	0.10	8.40	50.00	-41.60	AVG
6	12.3860	18.93	0.12	19.05	60.00	-40.95	peak

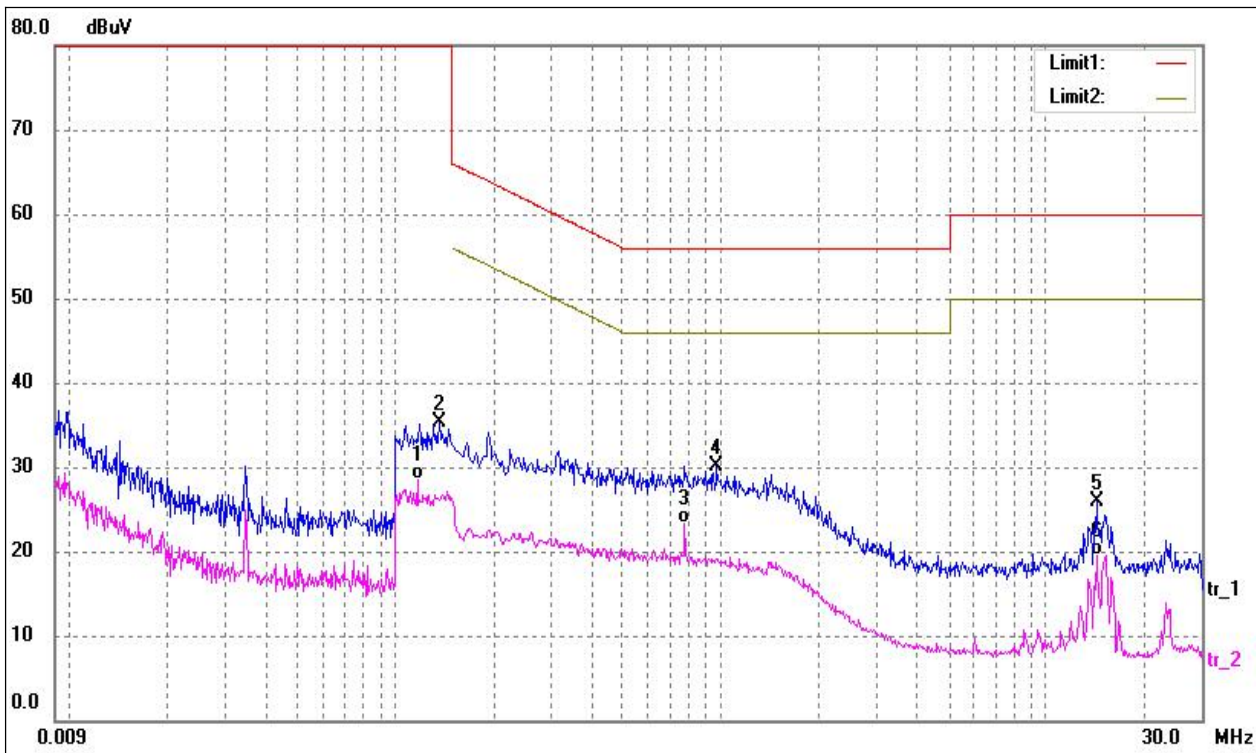

EUT:	LED MAGNETICTRACK LIGHTS	Model Name :	VT-4121
Temperature:	24 °C	Relative Humidity:	54%
Pressure:	1010 hPa	Test Date :	May 10, 2020
Test Mode :	Normal Operating	Polarization :	GND
Test Power :	DC 24V		

No.	Frequency (MHz)	Reading (dBuV)	Correct (dB/m)	Result (dBuV)	Limit (dBuV)	Margin (dB)	Detector
1	0.1175	27.96	0.46	28.42	58.02	-29.60	AVG
2	0.1372	34.96	0.41	35.37	80.81	-45.44	peak
3*	0.7780	23.13	0.09	23.22	46.00	-22.78	AVG
4	0.9780	29.95	0.08	30.03	56.00	-25.97	peak
5	14.3180	25.71	0.13	25.84	60.00	-34.16	peak
6	14.3180	19.43	0.13	19.56	50.00	-30.44	AVG

## 8.2. RADIATED ELECTROMAGNETIC DISTURBANCE

### 8.2.1. LIMITS

Frequency	Limits for loop diameter dB(μA)*		
	2m	3m	4m
9KHz-70KHz	88	81	75
70KHz-150KHz	88-58**	81-51**	75-45**
150KHz-3.0MHz	58-22**	51-22**	45-16**
3.0MHz-30MHz	22	15-16***	9-12***

\* At the transition frequency, the lower limit applies.

\*\* Decreasing linearly with the logarithm of the frequency.

\*\*\* Increasing linearly with the logarithm of the frequency.

Note: In Japan, the limits for frequencies 9KHz to 150KHz do not apply.

### 8.2.2. TEST PROCEDURE

In the frequency range 9KHz to 30MHz the interference capability of the magnetic field component of the radiation of Equipment Under Test (EUT) can be determined by using a special Loop Antenna System (LAS). In the LAS, this capability is measured in terms of the currents induced by the magnetic field in the loop antennas of the LAS. The LAS allows indoor measurement.

The LAS consists of three circular, mutually perpendicular Large-Loop Antennas (LLAs), having a diameter of 2 m, supported by a non-metallic base. A 50Ω coaxial cable between the current probe of an LLA and the coaxial switch, and between this switch and the measuring equipment, shall have a surface transfer impedance smaller than 10mΩ/m at 100KHz and 1mΩ/m at 10MHz.

The distance between the outer diameter of the loop antenna system and nearby objects, such as floor and walls, shall be at least 0.5m as per CISPR 15/ EN55015.

The EUT is positioned in the center of the LAS (To avoid unwanted capacitive coupling between the EUT and the LAS, the maximum dimensions of the EUT are limited so that the distance between the EUT and an LLA is at least 0.2m). Cables should be routed together and leave the loop volume in the same octant of the cell, no closer than 0.4m to the LAS loops.

The induced current in the loop antenna is measured by means of a current probe(1V/A) and the CISPR measuring receiver(or equivalent). By means of a coaxial switch, the three field direction(X, Y, Z) can be measured in sequence, and recorded at least the six highest emission. Each value shall fulfill the requirement given.

The test data of the worst-case condition(s) was recorded.

### 8.2.3. TEST SETUP

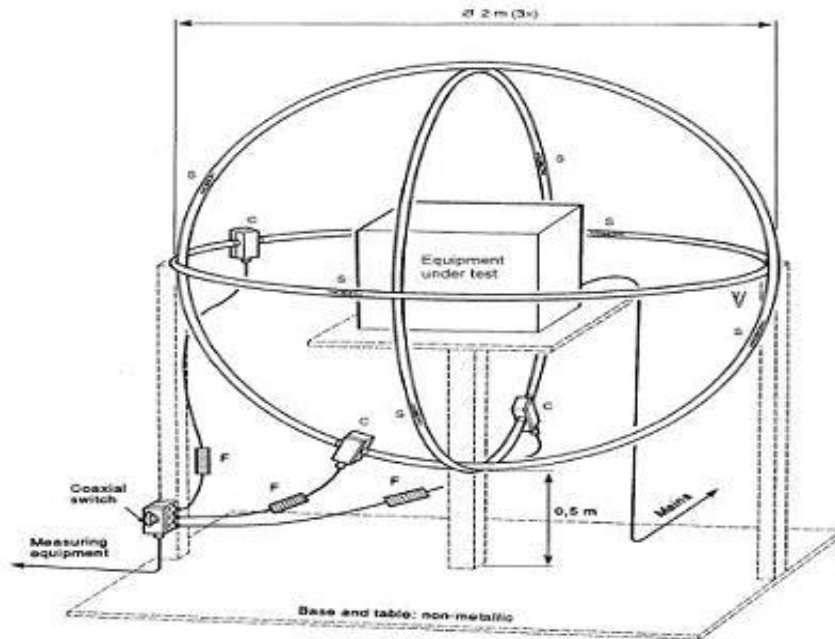

For the actual test configuration, please refer to the related item – Photographs of the Test Configuration.

### 8.2.4. TEST RESULTS

Temperature ( °C )	22~28
Humidity ( %RH )	50~58
Barometric Pressure ( mbar )	950~1000
EUT	LED MAGNETIC TRACK LIGHTS
M/N	VT-4121
Operating Mode	Normal Operating
Test Results	PASS



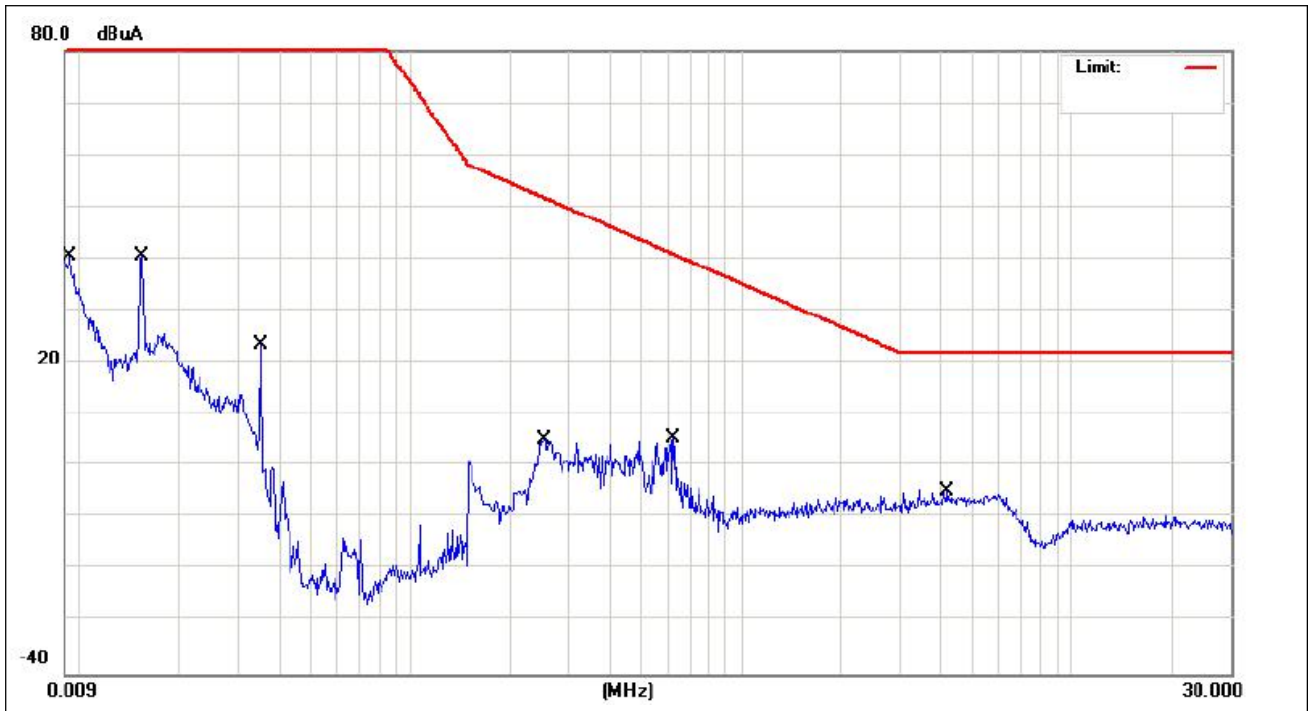

EUT:	LED MAGNETIC TRACK LIGHTS	Model Name :	VT-4121
Temperature:	24 °C	Relative Humidity:	54%
Pressure:	1010 hPa	Test Date :	May 10, 2020
Test Mode :	Normal Operating	Polarization :	X
Test Power :	DC 24V		

Item (Mark)	Freq (MHz)	Read Level (DBμA)	Cable Loss (dB)	Result Level (DBμA)	Limit Line (DBμA)	Over Limit (dB)	Detector	Phase
1	0.01	2.71	0.06	2.77	88.00	-85.23	Peak	X
2	0.03	6.80	0.16	6.96	88.00	-81.04	Peak	X
3	0.06	-10.03	0.23	-9.80	88.00	-97.80	Peak	X
4	0.08	-12.77	0.25	-12.52	85.09	-97.61	Peak	X
5	0.17	-15.37	0.33	-15.04	56.72	-71.76	Peak	X
6	3.92	-20.51	0.61	-19.90	22.00	-41.90	Peak	X

Remark:

1. All readings are Quasi-Peak and Average values.
2. Factor = Antenna Factor + Cable Loss - Amplifier.
3. N/A means All Data have pass Limit.

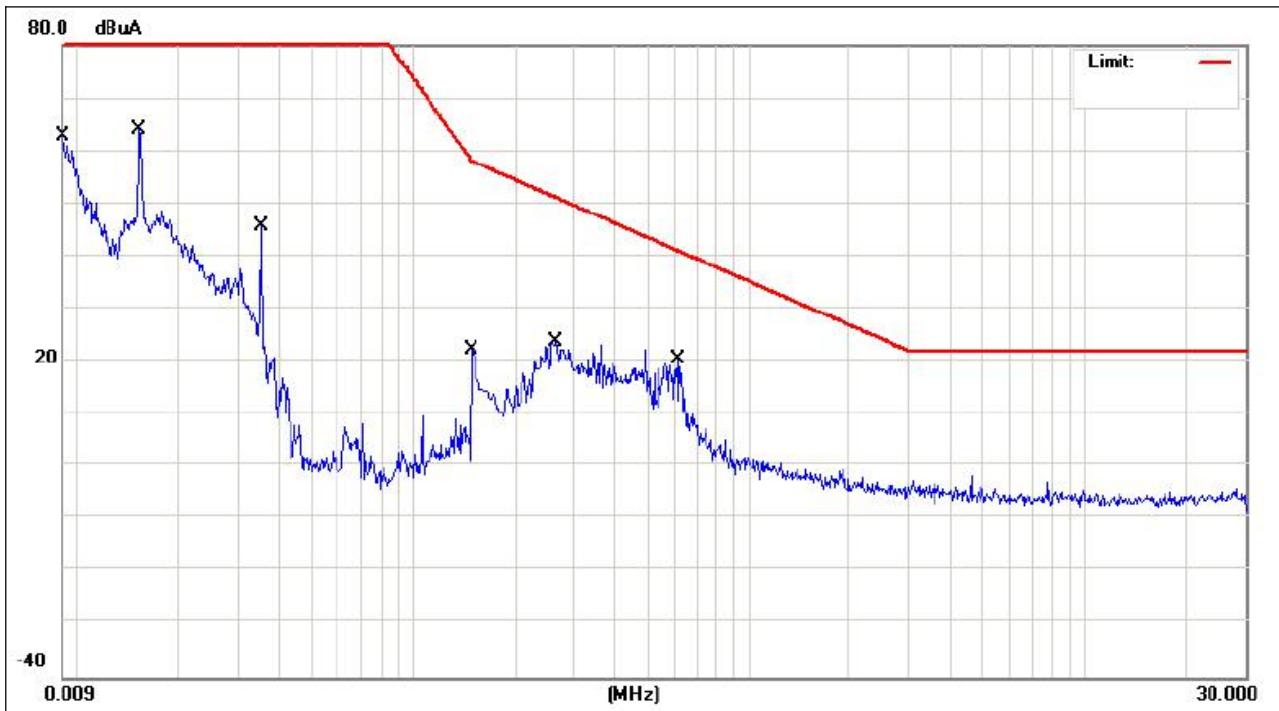

EUT:	LED MAGNETICTRACK LIGHTS	Model Name :	VT-4121
Temperature:	24 °C	Relative Humidity:	54%
Pressure:	1010 hPa	Test Date :	May 10, 2020
Test Mode :	Normal Operating	Polarization :	Y
Test Power :	DC 24V		

Item (Mark)	Freq (MHz)	Read Level (DBμA)	Cable Loss (dB)	Result Level (DBμA)	Limit Line (DBμA)	Over Limit (dB)	Detector	Phase
1	0.03	19.55	0.17	19.72	88.00	-68.28	Peak	Y
2	0.07	5.55	0.25	5.80	87.64	-81.84	Peak	Y
3	0.15	-0.53	0.31	-0.22	59.22	-59.44	Peak	Y
4	0.21	-4.33	0.35	-3.98	53.69	-57.67	Peak	Y
5	0.39	-12.49	0.40	-12.09	46.38	-58.47	Peak	Y
6	1.54	-19.37	0.53	-18.84	30.01	-48.85	Peak	Y

Remark:

- All readings are Quasi-Peak and Average values.
- Factor = Antenna Factor + Cable Loss - Amplifier.
- N/A means All Data have pass Limit.

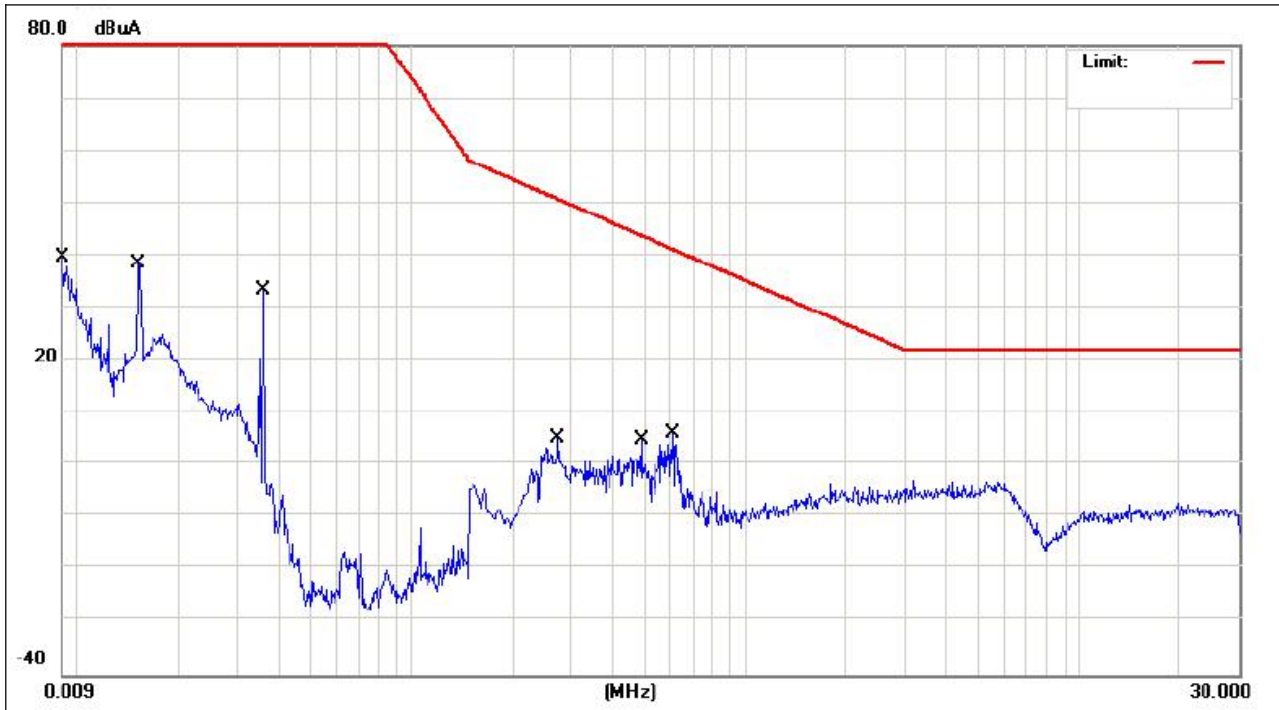

EUT:	LED MAGNETICTRACK LIGHTS	Model Name :	VT-4121
Temperature:	24 °C	Relative Humidity:	54%
Pressure:	1010 hPa	Test Date :	May 10, 2020
Test Mode :	Normal Operating	Polarization :	Z
Test Power :	DC 24V		

Item (Mark)	Freq (MHz)	Read Level (DBμA)	Cable Loss (dB)	Result Level (DBμA)	Limit Line (DBμA)	Over Limit (dB)	Detector	Phase
1	0.01	21.19	0.07	21.26	88.00	-66.74	Peak	Z
2	0.02	11.67	0.13	11.80	88.00	-76.20	Peak	Z
3	0.04	14.88	0.18	15.06	88.00	-72.94	Peak	Z
4	0.07	-3.50	0.25	-3.25	86.68	-89.93	Peak	Z
5	0.14	-14.44	0.31	-14.13	59.86	-73.99	Peak	Z
6	0.40	-17.88	0.41	-17.47	46.29	-63.76	Peak	Z

Remark:  
 1. All readings are Quasi-Peak and Average values.  
 2. Factor = Antenna Factor + Cable Loss - Amplifier.  
 3. N/A means All Data have pass Limit.

## 8.3. RADIATED EMISSION MEASUREMENT

### 8.3.1. LIMITS

FREQUENCY (MHz)	dBuV/m (At 3m)
30 ~ 230	40
230 ~ 300	47

**NOTE:** (1) The lower limit shall apply at the transition frequencies.

(2) Emission level (dBuV/m) = 20 log Emission level (uV/m).

### 8.3.2. TEST PROCEDURE

#### Procedure of Preliminary Test

The equipment was set up as per the test configuration to simulate typical usage per the user's manual. When the EUT is a tabletop system, a wooden turntable with a height of 0.8 meters is used which is placed on the ground plane. When the EUT is a floor standing equipment, it is placed on the ground plane which has a 3-12 mm non-conductive covering to insulate the EUT from the ground plane.

Support equipment, if needed, was placed as per EN 55015.

All I/O cables were positioned to simulate typical usage as per EN 55015.

Mains cables, telephone lines or other connections to auxiliary equipment located outside the test are shall drape to the floor, be fitted with ferrite clamps or ferrite tubes placed on the floor at the point where the cable reaches the floor and then routed to the place where they leave the turntable. No extension cords shall be used to mains receptacle.

The antenna was placed at 3 meter away from the EUT as stated in EN 55015. The antenna connected to the Spectrum Analyzer via a cable and at times a pre-amplifier would be used.

The Analyzer / Receiver quickly scanned from 30MHz to 300MHz. The EUT test program was started. Emissions were scanned and measured rotating the EUT to 360 degrees and positioning the antenna 1 to 4 meters above the ground plane, in both the vertical and the horizontal polarization, to maximize the emission reading level.

The test mode(s) described in Item 3.1 were scanned during the preliminary test:

After the preliminary scan, we found the test mode described in Item 3.1 producing the highest emission level. The EUT and cable configuration, antenna position, polarization and turntable position of the above highest emission level were recorded for the final test.

#### Procedure of Final Test

EUT and support equipment were set up on the turntable as per the configuration with highest emission level in the preliminary test.

The Analyzer / Receiver scanned from 30MHz to 300MHz. Emissions were scanned and measured rotating the EUT to 360 degrees, varying cable placement and positioning the antenna 1 to 4 meters above the ground plane, in both the vertical and the horizontal polarization, to maximize the emission reading level.

Recorded at least the six highest emissions. Emission frequency, amplitude, antenna position, polarization and turntable position were recorded into a computer in which correction factors were used to calculate the emission level and compare reading to the applicable limit and only Q.P. reading is presented.

The test data of the worst-case condition(s) was recorded.

### 8.3.3. TEST SETUP

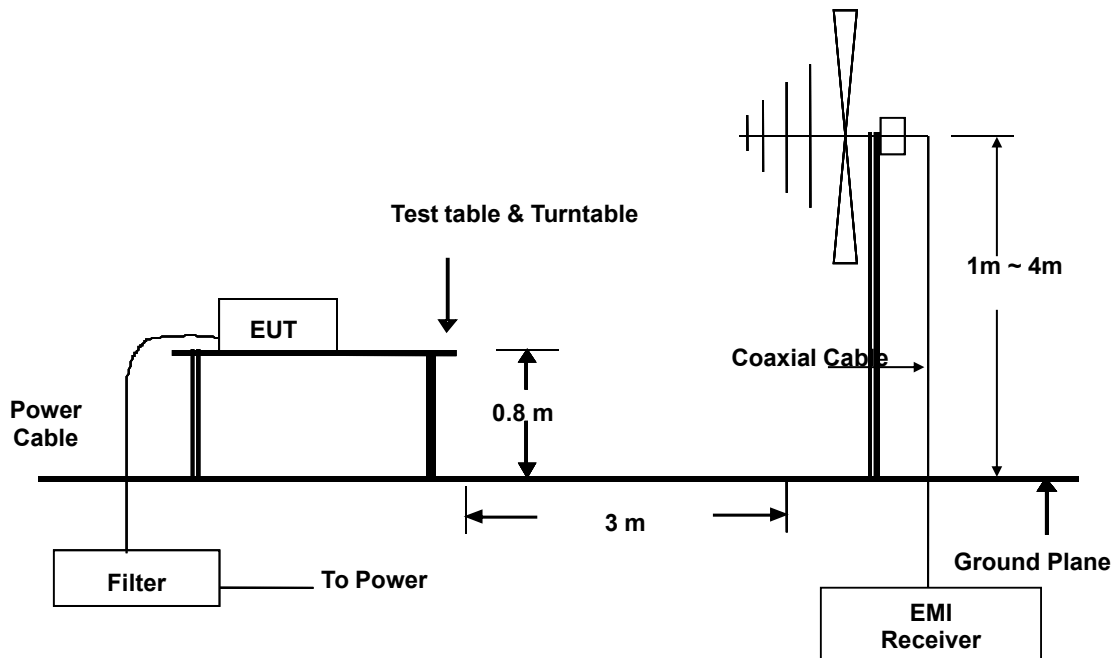

For the actual test configuration, please refer to the related item – Photographs of the Test Configuration.

### 8.3.4 TEST RESULTS

Temperature ( °C )	22~28
Humidity ( %RH )	50~58
Barometric Pressure ( mbar )	950~1000
EUT	LED MAGNETICTRACK LIGHTS
M/N	VT-4121
Operating Mode	Normal Operating
Test Results	PASS

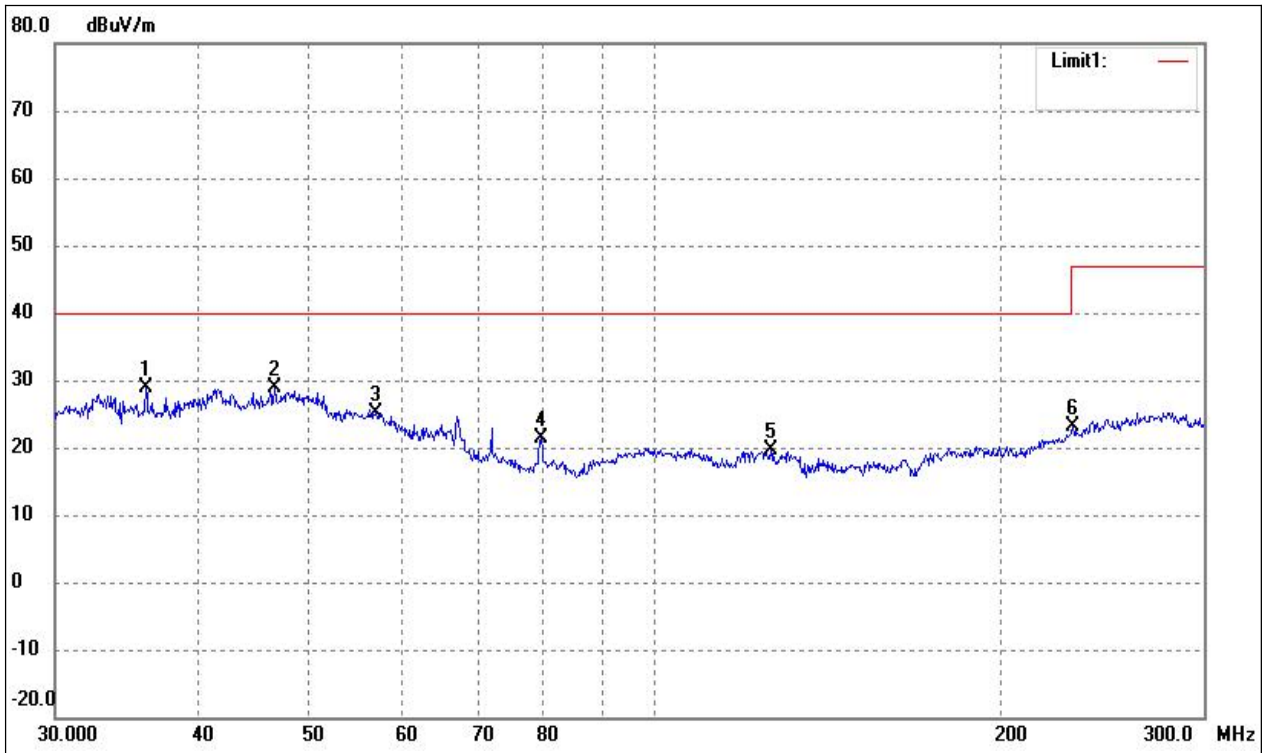

EUT:	LED MAGNETIC TRACK LIGHTS	Model Name :	VT-4121
Temperature:	24 °C	Relative Humidity:	54%
Pressure:	1010 hPa	Test Date :	May 10, 2020
Test Mode :	Normal Operating	Polarization :	Vertical
Test Power :	DC 24V		

No.	Frequency (MHz)	Reading (dBuV/m)	Correct (dB/m)	Result (dBuV/m)	Limit (dBuV/m)	Margin (dB)	Degree ( )	Height (cm)	Remark
1	35.9849	38.37	-9.48	28.89	40.00	-11.11			peak
2	46.5715	37.10	-8.11	28.99	40.00	-11.01			peak
3	57.0322	35.28	-10.07	25.21	40.00	-14.79			peak
4	79.4548	38.45	-16.97	21.48	40.00	-18.52			peak
5	125.9277	36.66	-17.13	19.53	40.00	-20.47			peak
6	230.7391	35.03	-12.00	23.03	47.00	-23.97			peak

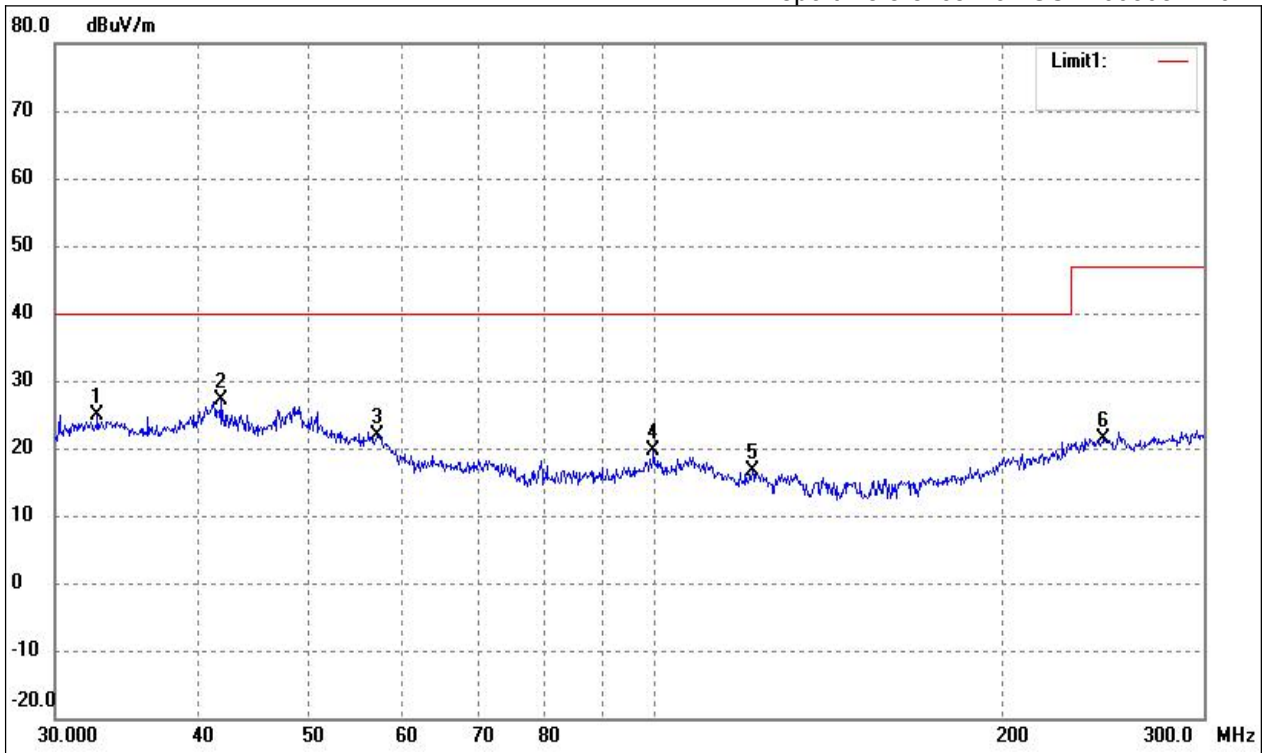

EUT:	LED MAGNETICTRACK LIGHTS	Model Name :	VT-4121
Temperature:	24 °C	Relative Humidity:	54%
Pressure:	1010 hPa	Test Date :	May 10, 2020
Test Mode :	Normal Operating	Polarization :	Horizontal
Test Power :	DC 24V		

No.	Frequency (MHz)	Reading (dBuV/m)	Correct (dB/m)	Result (dBuV/m)	Limit (dBuV/m)	Margin (dB)	Degree ( )	Height (cm)	Remark
1	32.6679	34.69	-9.75	24.94	40.00	-15.06			peak
2	41.8911	35.11	-8.06	27.05	40.00	-12.95			peak
3	57.2956	32.19	-10.21	21.98	40.00	-18.02			peak
4	99.5681	34.50	-14.93	19.57	40.00	-20.43			peak
5	121.3726	32.86	-16.29	16.57	40.00	-23.43			peak
6	245.5394	32.59	-11.23	21.36	47.00	-25.64			peak

## 8.4. HARMONICS CURRENT MEASUREMENT

### 8.4.1. LIMITS OF HARMONICS CURRENT MEASUREMENT

Limits for Class A equipment		Limits for Class D equipment		
Harmonics Order n	Max. permissible harmonics current A	Harmonics Order n	Max. permissible harmonics current per watt mA/W	Max. permissible harmonics current A
Odd harmonics		Odd Harmonics only		
3	2.30	3	3.4	2.30
5	1.14	5	1.9	1.14
7	0.77	7	1.0	0.77
9	0.40	9	0.5	0.40
11	0.33	11	0.35	0.33
13	0.21	13	0.30	0.21
15<=n<=39	0.15x15/n	15<=n<=39	3.85/n	0.15x15/n
Even harmonics				
2	1.08			
4	0.43			
6	0.30			
8<=n<=40	0.23x8/n			

**NOTE:** 1. Class A and Class D are classified according to item 4.4.3.

2. According to section 7 of EN 61000-3-2, the above limits apply for all equipments with a rated power more than 75W, except for lighting equipment.

### 8.4.2. TEST PROCEDURE

The EUT was placed on the top of a wooden table 0.8 meters above the ground and operated to produce the maximum harmonic components under LIGHTING operating conditions for each successive harmonic component in turn.

The classification of EUT is according to section 5 of EN 61000-3-2.

The EUT is classified as follows:

Class A: Balanced three-phase equipment, Household appliances excluding equipment as Class D, Tools excluding portable tools, Dimmers for incandescent lamps, audio equipment, equipment not specified in one of the three other classes.

Class B: Portable tools; Arc welding equipment which is not professional equipment.

Class C: Lighting equipment.

Class D: Equipment having a specified power less than or equal to 600 W of the following types: Personal computers and personal computer monitors and television receivers.

The correspondent test program of test instrument to measure the current harmonics emanated from EUT is chosen. The measure time shall be not less than the time necessary for the EUT to be exercised.



### 8.4.3. TEST SETUP

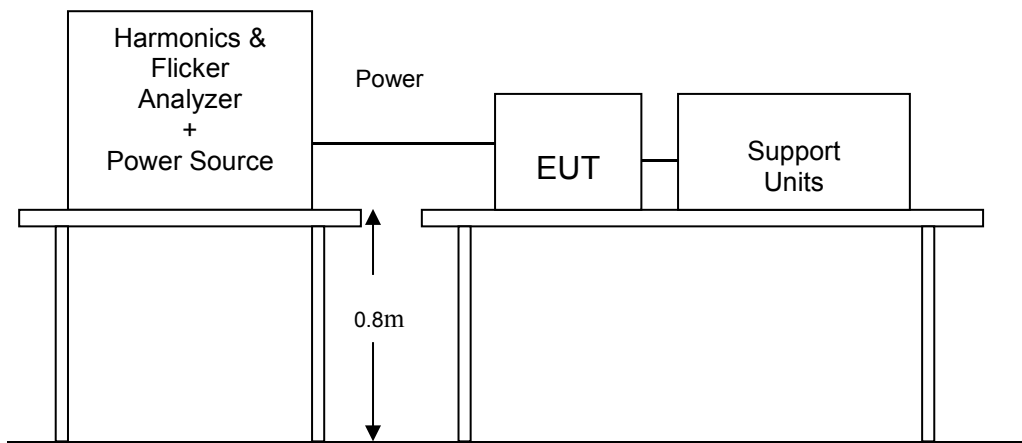

For the actual test configuration, please refer to the related item.

### 8.4.4. TEST RESULTS

Temperature ( °C )	22~28
Humidity ( %RH )	50~58
Barometric Pressure ( mbar )	950~1000
EUT	LED MAGNETICTRACK LIGHTS
M/N	VT-4121
Operating Mode	Normal Operating
Test Results	PASS

### E. U. T. Result

Harmonic(s) > 200%: Order (n):	None
Harmonic(s) with average > 90%: Order (n):	None
Harmonic(s) between 150% and 200% during more than 10% of the test time or max. 10min: Order (n):	None

### Power Source Result

First dataset out of limit: DS (time):	None
Harmonic(s) out of limit: Order (n):	None

*Average harmonic current results*

Hn	I <sub>eff</sub> [A]	I <sub>eff</sub> [%]	Limit [A]	Result
1	92.234E-3	100.000		
2	655.048E-6	0.710	972.00E-3	PASS
3	10.276E-3	11.142	2.07	PASS
4	2.069E-3	2.244	387.00E-3	PASS
5	4.270E-3	4.630	1.03	PASS
6	768.469E-6	0.833	270.00E-3	PASS
7	1.351E-3	1.465	693.00E-3	PASS
8	804.642E-6	0.872	207.00E-3	PASS
9	1.488E-3	1.613	360.00E-3	PASS
10	710.588E-6	0.770	165.60E-3	PASS
11	1.008E-3	1.093	297.00E-3	PASS
12	895.573E-6	0.971	138.00E-3	PASS
13	1.778E-3	1.928	189.00E-3	PASS
14	891.521E-6	0.967	118.29E-3	PASS
15	1.102E-3	1.195	135.00E-3	PASS
16	772.700E-6	0.838	103.50E-3	PASS
17	1.266E-3	1.372	119.11E-3	PASS
18	1.171E-3	1.270	92.00E-3	PASS
19	909.143E-6	0.986	106.58E-3	PASS
20	808.971E-6	0.877	82.80E-3	PASS
21	1.163E-3	1.261	96.43E-3	PASS
22	1.048E-3	1.136	75.28E-3	PASS
23	1.459E-3	1.581	88.05E-3	PASS
24	821.581E-6	0.891	68.99E-3	PASS
25	832.532E-6	0.903	81.00E-3	PASS
26	786.264E-6	0.852	63.69E-3	PASS
27	1.054E-3	1.142	75.00E-3	PASS
28	785.917E-6	0.852	59.14E-3	PASS
29	779.776E-6	0.845	69.83E-3	PASS
30	762.567E-6	0.827	55.20E-3	PASS
31	1.101E-3	1.194	65.32E-3	PASS
32	862.040E-6	0.935	51.75E-3	PASS
33	816.708E-6	0.885	61.36E-3	PASS
34	577.011E-6	0.626	48.71E-3	PASS
35	881.679E-6	0.956	57.86E-3	PASS
36	829.227E-6	0.899	46.00E-3	PASS
37	621.672E-6	0.674	54.73E-3	PASS
38	658.199E-6	0.714	43.58E-3	PASS
39	609.231E-6	0.661	51.92E-3	PASS
40	882.731E-6	0.957	41.40E-3	PASS

*Maximum harmonic current results*

Hn	I <sub>eff</sub> [A]	I <sub>eff</sub> [%]	Limit [A]	Result
1	92.748E-3	100.000		
2	727.927E-6	0.785	2.16	PASS
3	10.739E-3	11.579	4.60	PASS
4	2.219E-3	2.392	860.00E-3	PASS
5	4.428E-3	4.775	2.28	PASS
6	865.163E-6	0.933	600.00E-3	PASS
7	1.516E-3	1.634	1.54	PASS
8	949.202E-6	1.023	460.00E-3	PASS
9	1.592E-3	1.716	800.00E-3	PASS
10	807.329E-6	0.870	368.00E-3	PASS
11	1.144E-3	1.233	660.00E-3	PASS
12	1.011E-3	1.090	306.66E-3	PASS
13	1.871E-3	2.017	420.00E-3	PASS
14	1.021E-3	1.101	262.86E-3	PASS
15	1.188E-3	1.281	300.00E-3	PASS
16	895.833E-6	0.966	230.00E-3	PASS
17	1.357E-3	1.463	264.70E-3	PASS
18	1.279E-3	1.379	204.44E-3	PASS
19	1.010E-3	1.089	236.84E-3	PASS
20	957.397E-6	1.032	184.00E-3	PASS
21	1.309E-3	1.412	214.28E-3	PASS
22	1.160E-3	1.250	167.28E-3	PASS
23	1.551E-3	1.672	195.66E-3	PASS
24	913.210E-6	0.985	153.32E-3	PASS
25	980.837E-6	1.058	180.00E-3	PASS
26	872.214E-6	0.940	141.54E-3	PASS
27	1.164E-3	1.255	166.66E-3	PASS
28	866.918E-6	0.935	131.42E-3	PASS
29	874.169E-6	0.943	155.18E-3	PASS
30	821.839E-6	0.886	122.66E-3	PASS
31	1.226E-3	1.321	145.16E-3	PASS
32	1.001E-3	1.080	115.00E-3	PASS
33	889.147E-6	0.959	136.36E-3	PASS
34	702.045E-6	0.757	108.24E-3	PASS
35	1.056E-3	1.138	128.58E-3	PASS
36	1.049E-3	1.131	102.22E-3	PASS
37	683.656E-6	0.737	121.62E-3	PASS
38	720.106E-6	0.776	96.84E-3	PASS
39	704.946E-6	0.760	115.38E-3	PASS
40	962.540E-6	1.038	92.00E-3	PASS

*Maximum harmonic voltage results*

Hn	Ueff [V]	Ueff [%]	Limit [%]	Result
1	231.34	100.581		
2	75.91E-3	0.033	0.2	PASS
3	105.53E-3	0.046	0.9	PASS
4	19.46E-3	0.008	0.2	PASS
5	46.33E-3	0.020	0.4	PASS
6	14.92E-3	0.006	0.2	PASS
7	27.95E-3	0.012	0.3	PASS
8	15.24E-3	0.007	0.2	PASS
9	21.85E-3	0.009	0.2	PASS
10	11.40E-3	0.005	0.2	PASS
11	34.46E-3	0.015	0.1	PASS
12	12.73E-3	0.006	0.1	PASS
13	46.01E-3	0.020	0.1	PASS
14	10.98E-3	0.005	0.1	PASS
15	26.03E-3	0.011	0.1	PASS
16	13.69E-3	0.006	0.1	PASS
17	12.56E-3	0.005	0.1	PASS
18	11.05E-3	0.005	0.1	PASS
19	32.97E-3	0.014	0.1	PASS
20	11.27E-3	0.005	0.1	PASS
21	38.02E-3	0.017	0.1	PASS
22	10.70E-3	0.005	0.1	PASS
23	30.86E-3	0.013	0.1	PASS
24	13.61E-3	0.006	0.1	PASS
25	14.13E-3	0.006	0.1	PASS
26	12.75E-3	0.006	0.1	PASS
27	24.97E-3	0.011	0.1	PASS
28	14.51E-3	0.006	0.1	PASS
29	36.73E-3	0.016	0.1	PASS
30	11.32E-3	0.005	0.1	PASS
31	31.84E-3	0.014	0.1	PASS
32	9.87E-3	0.004	0.1	PASS
33	18.26E-3	0.008	0.1	PASS
34	11.12E-3	0.005	0.1	PASS
35	16.71E-3	0.007	0.1	PASS
36	9.52E-3	0.004	0.1	PASS
37	27.14E-3	0.012	0.1	PASS
38	11.82E-3	0.005	0.1	PASS
39	25.43E-3	0.011	0.1	PASS
40	11.20E-3	0.005	0.1	PASS

*Harmonic current results - DS: 12*

Hn	I <sub>eff</sub> [A]	I <sub>eff</sub> [%]	Limit [A]	Result
1	92.712E-3	100.000		
2	704.608E-6	0.760	1.08	PASS
3	10.639E-3	11.475	2.30	PASS
4	2.139E-3	2.307	430.00E-3	PASS
5	4.299E-3	4.636	1.14	PASS
6	832.811E-6	0.898	300.00E-3	PASS
7	1.445E-3	1.559	770.00E-3	PASS
8	884.116E-6	0.954	230.00E-3	PASS
9	1.363E-3	1.470	400.00E-3	PASS
10	763.749E-6	0.824	184.00E-3	PASS
11	875.233E-6	0.944	330.00E-3	PASS
12	972.537E-6	1.049	153.33E-3	PASS
13	1.856E-3	2.001	210.00E-3	PASS
14	979.993E-6	1.057	131.43E-3	PASS
15	1.026E-3	1.106	150.00E-3	PASS
16	839.819E-6	0.906	115.00E-3	PASS
17	1.220E-3	1.316	132.35E-3	PASS
18	1.218E-3	1.314	102.22E-3	PASS
19	904.638E-6	0.976	118.42E-3	PASS
20	936.464E-6	1.010	92.00E-3	PASS
21	1.018E-3	1.098	107.14E-3	PASS
22	1.055E-3	1.138	83.64E-3	PASS
23	1.318E-3	1.422	97.83E-3	PASS
24	860.203E-6	0.928	76.66E-3	PASS
25	935.082E-6	1.009	90.00E-3	PASS
26	854.993E-6	0.922	70.77E-3	PASS
27	994.117E-6	1.072	83.33E-3	PASS
28	829.497E-6	0.895	65.71E-3	PASS
29	780.429E-6	0.842	77.59E-3	PASS
30	734.336E-6	0.792	61.33E-3	PASS
31	1.049E-3	1.131	72.58E-3	PASS
32	887.986E-6	0.958	57.50E-3	PASS
33	759.486E-6	0.819	68.18E-3	PASS
34	613.586E-6	0.662	54.12E-3	PASS
35	1.038E-3	1.120	64.29E-3	PASS
36	693.755E-6	0.748	51.11E-3	PASS
37	652.006E-6	0.703	60.81E-3	PASS
38	679.788E-6	0.733	48.42E-3	PASS
39	625.308E-6	0.674	57.69E-3	PASS
40	874.345E-6	0.943	46.00E-3	PASS

Caution: Results related to the 100% limit values

*Harmonic voltage results - DS: 12*

Hn	Ueff [V]	Ueff [%]	Limit [%]	Result
1	231.31	100.571		
2	60.54E-3	0.026	0.2	PASS
3	70.76E-3	0.031	0.9	PASS
4	12.76E-3	0.006	0.2	PASS
5	43.49E-3	0.019	0.4	PASS
6	9.52E-3	0.004	0.2	PASS
7	11.86E-3	0.005	0.3	PASS
8	9.42E-3	0.004	0.2	PASS
9	6.10E-3	0.003	0.2	PASS
10	2.47E-3	0.001	0.2	PASS
11	28.26E-3	0.012	0.1	PASS
12	7.73E-3	0.003	0.1	PASS
13	34.07E-3	0.015	0.1	PASS
14	4.93E-3	0.002	0.1	PASS
15	22.34E-3	0.010	0.1	PASS
16	7.46E-3	0.003	0.1	PASS
17	7.60E-3	0.003	0.1	PASS
18	3.05E-3	0.001	0.1	PASS
19	27.28E-3	0.012	0.1	PASS
20	6.86E-3	0.003	0.1	PASS
21	26.25E-3	0.011	0.1	PASS
22	2.17E-3	0.001	0.1	PASS
23	26.23E-3	0.011	0.1	PASS
24	6.31E-3	0.003	0.1	PASS
25	11.13E-3	0.005	0.1	PASS
26	3.71E-3	0.002	0.1	PASS
27	15.02E-3	0.007	0.1	PASS
28	2.47E-3	0.001	0.1	PASS
29	26.57E-3	0.012	0.1	PASS
30	7.69E-3	0.003	0.1	PASS
31	21.76E-3	0.009	0.1	PASS
32	2.83E-3	0.001	0.1	PASS
33	12.78E-3	0.006	0.1	PASS
34	2.58E-3	0.001	0.1	PASS
35	7.26E-3	0.003	0.1	PASS
36	2.74E-3	0.001	0.1	PASS
37	19.96E-3	0.009	0.1	PASS
38	7.82E-3	0.003	0.1	PASS
39	18.18E-3	0.008	0.1	PASS
40	4.23E-3	0.002	0.1	PASS

## 8.5. VOLTAGE FLUCTUATION AND FLICKS MEASUREMENT

### 8.5.1. LIMITS OF VOLTAGE FLUCTUATION AND FLICKS MEASUREMENT

TEST ITEM	LIMIT	REMARK
$P_{st}$	1.0	$P_{st}$ means short-term flicker indicator.
$P_{lt}$	0.65	$P_{lt}$ means long-term flicker indicator.
$T_{dt}$ (ms)	500	$T_{dt}$ means maximum time that dt exceeds 3 %.
$d_{max}$ (%)	4%	$d_{max}$ means maximum relative voltage change.
dc (%)	3.3%	dc means relative steady-state voltage change

### 8.5.2. TEST PROCEDURE

The EUT was placed on the top of a wooden table 0.8 meters above the ground and operated to produce the most unfavorable sequence of voltage changes under LIGHTING operating conditions.

During the flick measurement, the measure time shall include that part of whole operation cycle in which the EUT produce the most unfavorable sequence of voltage changes. The observation period for short-term flicker indicator is 10 minutes and the observation period for long-term flicker indicator is 2 hours.

### 8.5.3. TEST SETUP

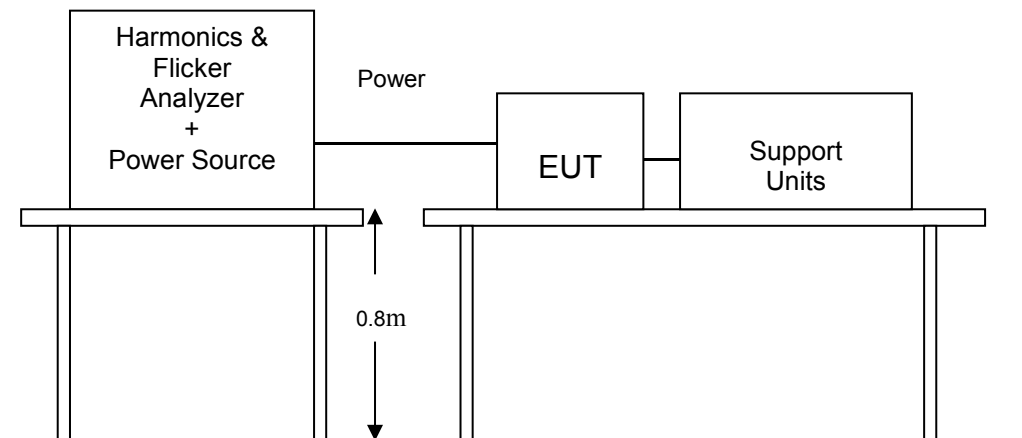

For the actual test configuration, please refer to the related item.



#### 8.5.4. TEST RESULTS

Temperature ( °C )	22~28
Humidity ( %RH )	50~58
Barometric Pressure ( mbar )	950~1000
EUT	LED MAGNETICTRACK LIGHTS
M/N	VT-4121
Operating Mode	Normal Operating
Test Results	PASS

#### Maximum Flicker results

	EUT values	Limit	Result
Pst	0.028	1.00	PASS
Plt	0.028	0.65	PASS
dc [%]	0.005	3.30	PASS
dmax [%]	0.269	4.00	PASS
dt [s]	0.000	0.50	PASS

## 9. IMMUNITY TEST

### 9.1. GENERAL DESCRIPTION

Product Standard	EN 61547: 2009	
	Test Type	Minimum Requirement
Basic Standard, Specification, and Performance Criterion required	EN61000-4-2:2009	Electrostatic Discharge – ESD: 8kV air discharge, 4kV Contact discharge, Performance Criterion B
	EN61000-4-3:2006+A1:2008 +A2:2010	Radio-Frequency Electromagnetic Field Susceptibility Test – RS: 80 ~1000 MHz, 3V/m, 80% AM(1kHz), Performance Criterion A
	EN61000-4-4:2012	Electrical Fast Transient/Burst - EFT, Power line: 1kV, Signal line: 0.5kV, Performance Criterion B
	EN61000-4-5:2014	Surge Immunity Test: 1.2/50 us Open Circuit Voltage, 8 /20 us Short Circuit Current, Power Port ~ Line to line: 0.5kV, Line to ground: 1kV ( to self-ballasted lamps and semi-luminaires; luminaires and independent auxiliaries which are less than 25W) Power Port ~ Line to line: 1kV, Line to ground: 2kV (to luminaires and independent auxiliaries which are more than 25W) Signal Port : 0.5kV Performance Criterion B
	EN61000-4-6:2014	Conducted Radio Frequency Disturbances Test –CS: 0.15 ~ 80 MHz, 3Vrms, 80% AM, 1kHz, Performance Criterion A
	EN61000-4-8: 2010	Power frequency magnetic field immunity test 50 Hz, 3A/m Performance Criterion A
	EN61000-4-11:2004	Voltage Dips and Interruptions: ii) 30% reduction for 10 period, Performance Criterion C 100% reduction for 0.5 period Performance Criterion B

## 9.2. GENERAL PERFORMANCE CRITERIA DESCRIPTION

<b>Criteria A:</b>	During the test no change of the luminous intensity shall be observed and the regulating control, if any, shall operate during the test as intended.
<b>Criteria B:</b>	During the test the luminous intensity may change to any value. After the test the luminous intensity shall be restored to its initial value within 1 min. Regulating controls need not function during the test, but after the test the mode of the control shall be the same as before the test provided that during the test no mode changing commands were given.
<b>Criteria C:</b>	During and after the test any change of the luminous intensity is allowed and the lamp(s) may be extinguished. After the test, within 30 min, all functions shall return to LED TUBE if necessary by temporary interruption of the mains supply and/or operating the regulating control. Additional requirement for lighting equipment incorporating a starting device: After the test the lighting equipment is switched off. After half an hour it is switched on again. The lighting equipment shall start and operate as intended.

## 9.3. ELECTROSTATIC DISCHARGE (ESD)

### 9.3.1. TEST SPECIFICATION

<b>Basic Standard:</b>	EN 61000-4-2
<b>Discharge Impedance:</b>	330ohm
<b>Charging Capacity:</b>	150pF
<b>Discharge Voltage:</b>	Air Discharge: 8 kV (Direct) Contact Discharge: 4 kV (Direct/Indirect)
<b>Polarity:</b>	Positive & Negative
<b>Number of Discharge:</b>	Minimum 10 times at each test point
<b>Discharge Mode:</b>	1 time/s
<b>Performance Criterion:</b>	B

### 9.3.2. TEST PROCEDURE

The discharges shall be applied in two ways:

- a) Contact discharges to the conductive surfaces and coupling planes:  
Twenty dischargers (10 with positive and 10 with negative polarity) shall be applied on each accessible metallic part of the enclosure, terminals are excluded. In case of a non-conductive enclosure, dischargers shall be applied on the horizontal or vertical coupling planes. Test shall be performed at a maximum repetition rate of one discharge per second.
- b) Air discharges at slots and apertures and insulating surfaces:  
On those parts of the EUT where it is not possible to perform contact discharge testing, the equipment should be investigated to identify user accessible points where breakdown may occur. Such points are tested using the air discharge method. This investigation should be restricted to those area normally handled by the user. A minimum of 10 single air discharges shall be applied to the selected test point for each such area.

The basic test procedure was in accordance with IEC 61000-4-2:

- a) The EUT was located 0.1 m minimum from all side of the **HCP** (dimensions 1.6m x 0.8m).
- b) The support units were located another table 30 cm away from the EUT, but direct support unit was/were located at same location as EUT on the HCP and keep at a distance of 10 cm with EUT.
- c) The time interval between two successive single discharges was at least 1 second.
- d) Contact discharges were applied to the non-insulating coating, with the pointed tip of the generator penetrating the coating and contacting the conducting substrate.
- e) Air discharges were applied with the round discharge tip of the discharge electrode approaching the EUT as fast as possible (without causing mechanical damage) to touch the EUT. After each discharge, the ESD generator was removed from the EUT and re-triggered for a new single discharge. The test was repeated until all discharges were complete.
- f) At least ten single discharges (in the most sensitive polarity) were applied at the front edge of each **HCP** opposite the center point of each unit of the EUT and 0.1 meters from the front of the EUT. The long axis of the discharge electrode was in the plane of the **HCP** and perpendicular to its front edge during the discharge.
- g) At least ten single discharges (in the most sensitive polarity) were applied to the center of one vertical edge of the **Vertical Coupling Plane (VCP)** in sufficiently different positions that the four faces of the EUT were completely illuminated. The **VCP** (dimensions 0.5m x 0.5m) was placed vertically to and 0.1 meters from the EUT.

### 9.3.3. TEST SETUP

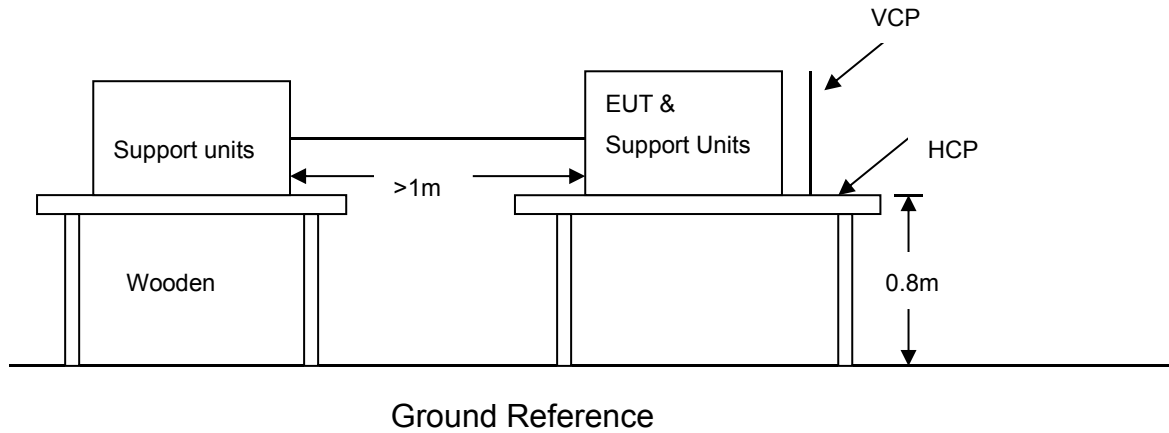

For the actual test configuration, please refer to the related item – Photographs of the Test Configuration.

**NOTE:**

TABLE-TOP EQUIPMENT

The configuration consisted of a wooden table 0.8 meters high standing on the **Ground Reference Plane**. The **GRP** consisted of a sheet of aluminum at least 0.25mm thick, and 2.5 meters square connected to the protective grounding system. A **Horizontal Coupling Plane** (1.6m x 0.8m) was placed on the table and attached to the **GRP** by means of a cable with 940k total impedance. The equipment under test, was installed in a representative system as described in section 7 of EN 61000-4-2, and its cables were placed on the **HCP** and isolated by an insulating support of 0.5mm thickness. A distance of 1-meter minimum was provided between the EUT and the walls of the laboratory and any other metallic structure.

FLOOR-STANDING EQUIPMENT

The equipment under test was installed in a representative system as described in section 7 of IEC 61000-4-2, and its cables were isolated from the Ground Reference Plane by an insulating support of 0.1-meter thickness. The GRP consisted of a sheet of aluminum that is at least 0.25mm thick, and 2.5 meters square connected to the protective grounding system and extended at least 0.5 meters from the EUT on all sides.

### 9.3.4. TEST RESULTS

Temperature ( °C )	22~28
Humidity ( %RH )	50~58
Barometric Pressure ( mbar )	950~1000
EUT	LED MAGNETICTRACK LIGHTS
M/N	VT-4121
Operating Mode	Normal Operating
Test Results	PASS

Air Discharge						
Test Points		Test Levels	Results			
		± 8 kV	Pass	Fail	Performance Criterion	Observation
Slots	6Points	<input checked="" type="checkbox"/>	<input checked="" type="checkbox"/>	<input type="checkbox"/>	B	Note <input type="checkbox"/> 1 <input checked="" type="checkbox"/> 2
Port	2Points	<input checked="" type="checkbox"/>	<input checked="" type="checkbox"/>	<input type="checkbox"/>	B	Note <input type="checkbox"/> 1 <input checked="" type="checkbox"/> 2

Contact Discharge						
Test Points		Test Levels	Results			
		± 4 kV	Pass	Fail	Performance Criterion	Observation
Metal	4Points	<input checked="" type="checkbox"/>	<input checked="" type="checkbox"/>	<input type="checkbox"/>	B	Note <input type="checkbox"/> 1 <input checked="" type="checkbox"/> 2
HCP	4Points	<input checked="" type="checkbox"/>	<input checked="" type="checkbox"/>	<input type="checkbox"/>	B	Note <input type="checkbox"/> 1 <input checked="" type="checkbox"/> 2
VCP	4Points	<input checked="" type="checkbox"/>	<input checked="" type="checkbox"/>	<input type="checkbox"/>	B	Note <input type="checkbox"/> 1 <input checked="" type="checkbox"/> 2

- NOTE:** 1. There was no change compared with initial operation during the test.  
 2. The loss of function of the EUT during the test and it was recovered by itself operation after the test.

## 9.4. RADIATED, RADIO-FREQUENCY, ELECTROMAGNETIC FIELD (RS)

### 9.4.1. TEST SPECIFICATION

<b>Basic Standard:</b>	EN 61000-4-3
<b>Frequency Range:</b>	80 MHz ~1000 MHz,
<b>Field Strength:</b>	3 V/m
<b>Modulation:</b>	1kHz Sine Wave, 80%, AM Modulation
<b>Frequency Step:</b>	1 % of preceding frequency value
<b>Polarity of Antenna:</b>	Horizontal and Vertical
<b>Test Distance:</b>	3 m
<b>Antenna Height:</b>	1.5m
<b>Performance Criterion:</b>	A

### 9.4.2. TEST PROCEDURE

The test procedure was in accordance with EN 61000-4-3

- a) The testing was performed in a fully anechoic chamber. The transmit antenna was located at a distance of 3 meters from the EUT.
- b) The frequency range is swept from 80 MHz to 1000 MHz, with the signal 80% amplitude modulated with a 1 kHz sine-wave. The rate of sweep did not exceed  $1.5 \times 10^{-3}$  decade/s, where the frequency range is swept incrementally; the step size was 1% of preceding frequency value.
- c) The dwell time at each frequency shall be not less than the time necessary for the EUT to be able to respond.
- d) The test was performed with the EUT exposed to both vertically and horizontally polarized fields on each of the four sides.

### 9.4.3. TEST SETUP

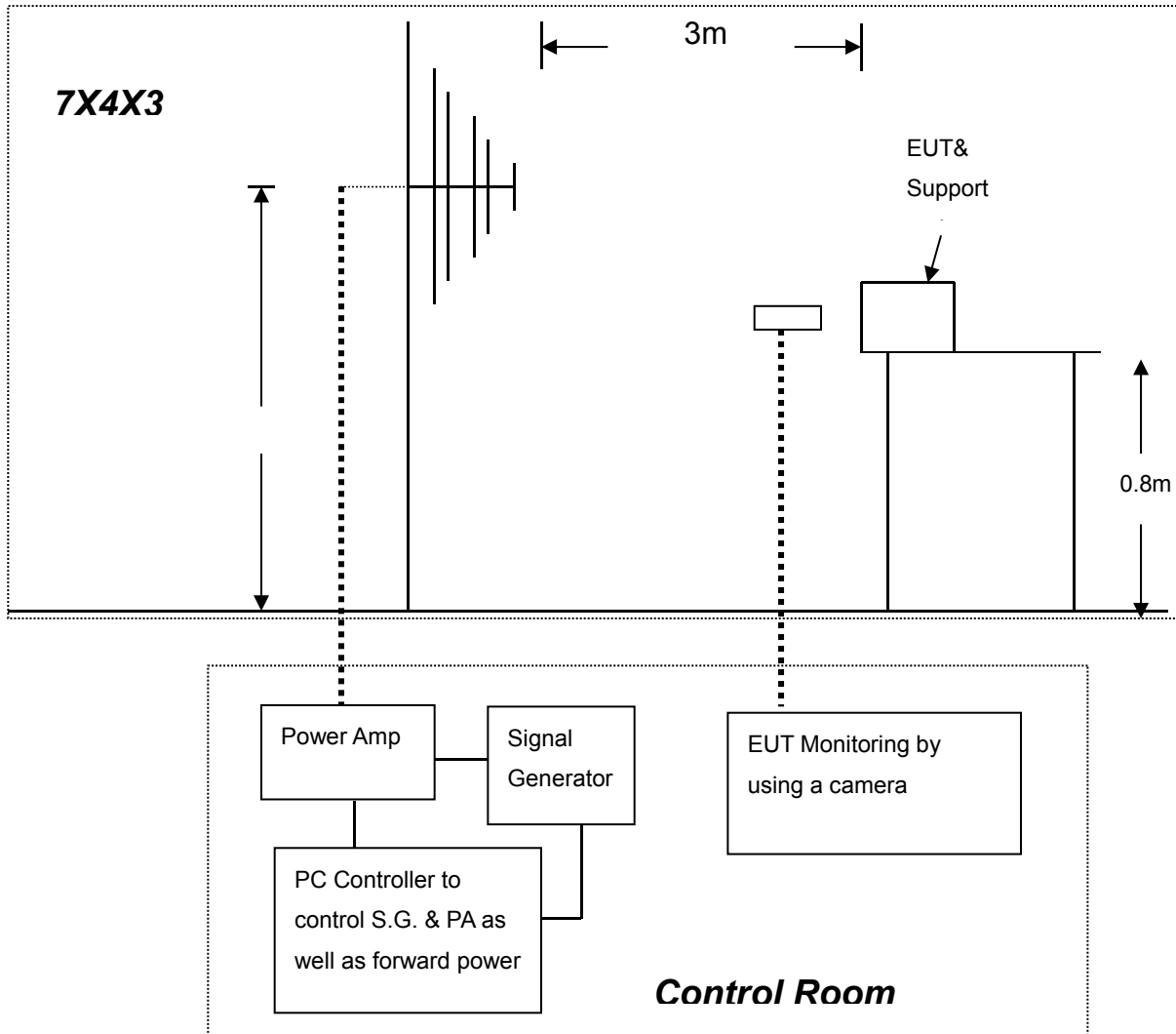

For the actual test configuration, please refer to the related item.

**NOTE:**

TABLETOP EQUIPMENT

The EUT installed in a representative system as described in section 7 of EN 61000-4-3 was placed on a non-conductive table 0.8 meters in height. The system under test was connected to the power and signal wire according to relevant installation instructions.

FLOOR STANDING EQUIPMENT

The EUT installed in a representative system as described in section 7 of IEC 61000-4-3 was placed on a non-conductive wood support 0.1 meters in height. The system under test was connected to the power and signal wire according to relevant installation instructions.



#### 9.4.4. TEST RESULTS

Temperature ( °C )	22~28
Humidity ( %RH )	50~58
Barometric Pressure ( mbar )	950~1000
EUT	LED MAGNETICTRACK LIGHTS
M/N	VT-4121
Operating Mode	Normal Operating
Test Results	PASS

Frequency (MHz)	Polarity	Position	Field Strength (V/m)	Observation	Result
80 ~ 1000	V&H	Front	3	Note	PASS
80 ~ 1000	V&H	Rear	3	Note	PASS
80 ~ 1000	V&H	Left	3	Note	PASS
80 ~ 1000	V&H	Right	3	Note	PASS

**NOTE:** There was no change compared with the initial operation during the test.

## 9.5. ELECTRICAL FAST TRANSIENT (EFT)

### 9.5.1. TEST SPECIFICATION

<b>Basic Standard:</b>	EN 61000-4-4
<b>Test Voltage:</b>	Power Line: 1 kV Signal/Control Line: 0.5 kV
<b>Polarity:</b>	Positive & Negative
<b>Impulse Frequency:</b>	5 kHz
<b>Impulse Wave-shape:</b>	5/50 ns
<b>Burst Duration:</b>	15 ms
<b>Burst Period:</b>	300ms
<b>Test Duration:</b>	Not less than 1 min.
<b>Performance Criterion:</b>	B

### 9.5.2. TEST PROCEDURE

- a) Both positive and negative polarity discharges were applied.
- b) The length of the “hot wire” from the coaxial output of the EFT generator to the terminals on the EUT should not exceed 1 meter.
- c) The duration time of each test sequential was 1 minute.
- d) The transient/burst waveform was in accordance with EN 61000-4-4, 5/50ns.

### 9.5.3. TEST SETUP

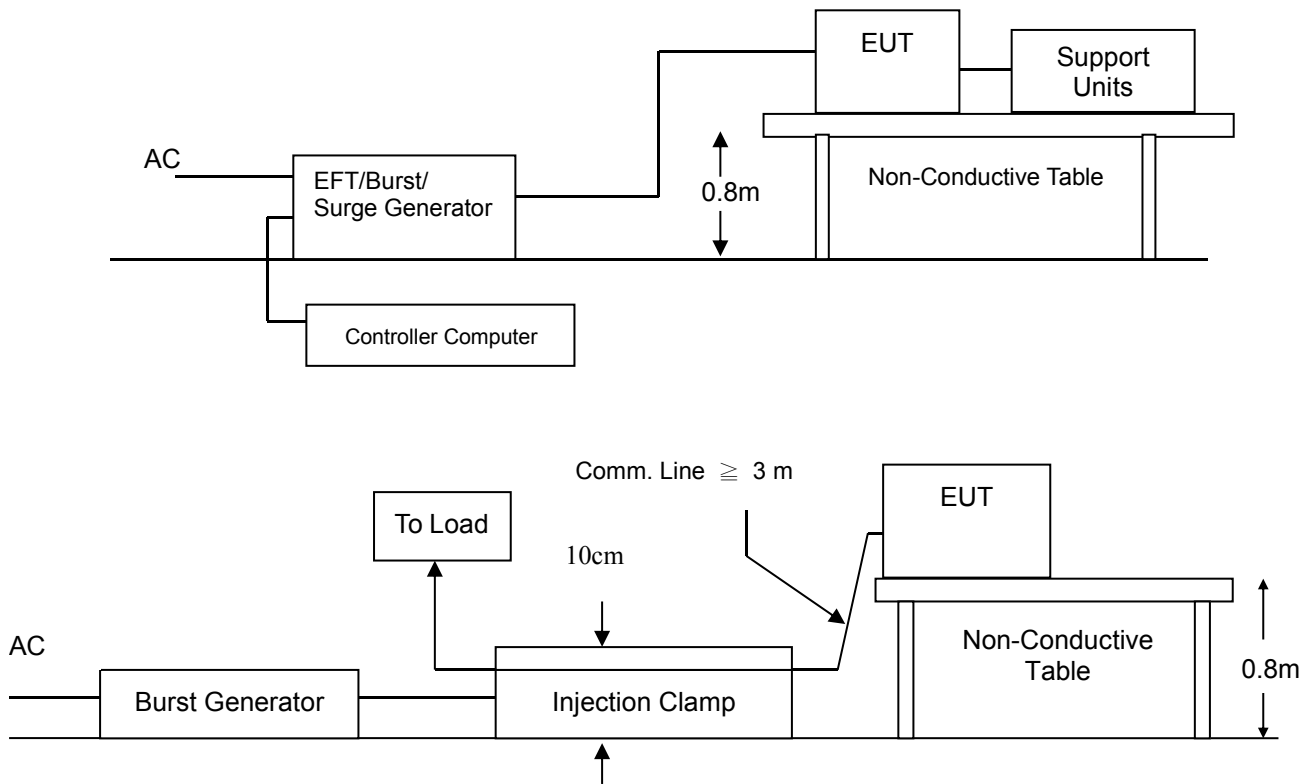

For the actual test configuration, please refer to the related item – Photographs of the Test Configuration.

**NOTE:**

TABLETOP EQUIPMENT

The configuration consisted of a wooden table (0.8m high) standing on the Ground Reference Plane. The GRP consisted of a sheet of aluminum (at least 0.25mm thick and 2.5m square) connected to the protective grounding system. A minimum distance of 0.5m was provided between the EUT and the walls of the laboratory or any other metallic structure.

FLOOR STANDING EQUIPMENT

The EUT installed in a representative system as described in section 7 of IEC 61000-4-4 and its cables, were isolated from the Ground Reference Plane by an insulating support that is 0.1-meter thick. The GRP consisted of a sheet of aluminum (at least 0.25mm thick and 2.5m square) connected to the protective grounding system.

#### 9.5.4. TEST RESULTS

Temperature ( °C )	22~28
Humidity ( %RH )	50~58
Barometric Pressure ( mbar )	950~1000
EUT	LED MAGNETICTRACK LIGHTS
M/N	VT-4121
Operating Mode	Normal Operating
Test Results	PASS

Test Point	Polarity	Test Level (kV)	Performance Criterion	Observation	Result
L 1	+/-	1	B	Note <input type="checkbox"/> 1 <input checked="" type="checkbox"/> 2	PASS
L 2	+/-	1	B	Note <input type="checkbox"/> 1 <input checked="" type="checkbox"/> 2	PASS
L 1-L 2	+/-	1	B	Note <input type="checkbox"/> 1 <input checked="" type="checkbox"/> 2	PASS
PE	+/-	1	B	Note <input type="checkbox"/> 1 <input checked="" type="checkbox"/> 2	N/A
L – PE	+/-	1	B	Note <input type="checkbox"/> 1 <input checked="" type="checkbox"/> 2	N/A
N – PE	+/-	1	B	Note <input type="checkbox"/> 1 <input checked="" type="checkbox"/> 2	N/A
L – N – PE	+/-	1	B	Note <input type="checkbox"/> 1 <input checked="" type="checkbox"/> 2	N/A
RJ45 UTP cable	--	--	--	Note <input type="checkbox"/> 1 <input type="checkbox"/> 2	N/A

- NOTE:** 1. There was no change compared with initial operation during the test.  
 2. The loss of function of the EUT during the test and it was recovered by itself operation after the test.

## 9.6. SURGE IMMUNITY TEST

### 9.6.1 TEST SPECIFICATION

<b>Basic Standard:</b>	EN 61000-4-5
<b>Wave-Shape:</b>	Combination Wave 1.2/50 us Open Circuit Voltage 8/20 us Short Circuit Current
<b>Test Voltage:</b>	Power line ~ line to line: 1 kV; line to ground: 2kV Telecommunication line: 1 kV;
<b>Surge Input/Output:</b>	Power Line: L-N/ N-PE / L-PE Telecommunication line: T-Ground / R-Ground
<b>Generator Source Impedance:</b>	2 ohm between networks 12 ohm between network and ground
<b>Polarity:</b>	Positive/Negative
<b>Phase Angle:</b>	90/ 270
<b>Pulse Repetition Rate:</b>	1 time / min. (maximum)
<b>Number of Tests:</b>	5 positive and 5 negative at selected points
<b>Performance Criterion:</b>	B

### 9.6.2. TEST PROCEDURE

a) For EUT power supply:

The surge is applied to the EUT power supply terminals via the capacitive coupling network. Decoupling networks are required in order to avoid possible adverse effects on equipment not under test that may be powered by the same lines, and to provide sufficient decoupling impedance to the surge wave. The power cord between the EUT and the coupling/decoupling networks was shorter than 2 meters in length.

b) For test applied to unshielded un-symmetrically operated interconnection lines of EUT:

The surge was applied to the lines via the capacitive coupling. The coupling / decoupling networks didn't influence the specified functional conditions of the EUT. The interconnection line between the EUT and the coupling/decoupling networks was shorter than 2 meters in length.

c) For test applied to unshielded symmetrically operated interconnection / telecommunication lines of EUT:

The surge was applied to the lines via gas arrestors coupling. Test levels below the ignition point of the coupling arrestor were not specified. The interconnection line between the EUT and the coupling/decoupling networks was shorter than 2 meters in length.

### 9.6.3. TEST SETUP

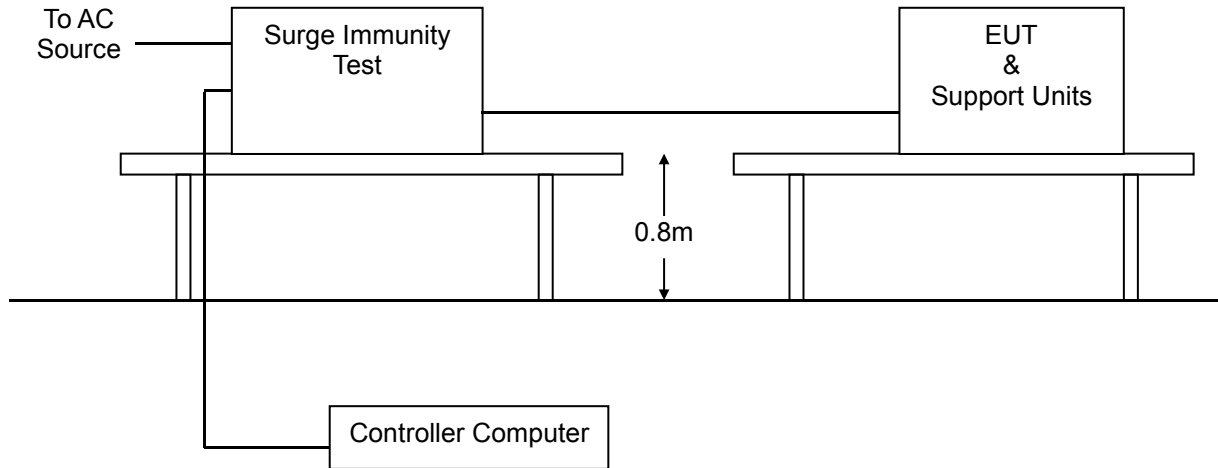

For the actual test configuration, please refer to the related item – Photographs of the Test Configuration.

### 9.6.4. TEST RESULTS

Temperature ( °C )	22~28
Humidity ( %RH )	50~58
Barometric Pressure ( mbar )	950~1000
EUT	LED MAGNETIC TRACK LIGHTS
M/N	VT-4121
Operating Mode	Normal Operating
Test Results	PASS

Test Point	Polarity	Test Level (kV)	Performance Criterion	Observation	Result
L - N	+/-	0.5	B	Note <input type="checkbox"/> 1 <input checked="" type="checkbox"/> 2	PASS
L - PE	/	/	/	Note <input type="checkbox"/> 1 <input type="checkbox"/> 2	N/A
N - PE	/	1	/	Note <input type="checkbox"/> 1 <input type="checkbox"/> 2	N/A
R - Ground	/	/	/	Note <input type="checkbox"/> 1 <input type="checkbox"/> 2	N/A
T - Ground	/	/	/	Note <input type="checkbox"/> 1 <input type="checkbox"/> 2	N/A

**NOTE:** 1. There was no change compared with initial operation during the test.  
 2. The loss of function of the EUT during the test and it was recovered by itself operation after the test.

## 9.7. CONDUCTED RADIO FREQUENCY DISTURBANCES (CS)

### 9.7.1. TEST SPECIFICATION

<b>Basic Standard:</b>	EN 61000-4-6
<b>Frequency Range:</b>	0.15 MHz ~ 80 MHz
<b>Field Strength:</b>	3 V
<b>Modulation:</b>	1kHz Sine Wave, 80%, AM Modulation
<b>Frequency Step:</b>	1 % of preceding frequency value
<b>Coupled cable:</b>	Power Mains, Shielded
<b>Coupling device:</b>	CDN-M3/2 (3 wires)
<b>Performance Criterion:</b>	A

### 9.7.2. TEST PROCEDURE

The EUT shall be tested within its intended operating and climatic conditions.

The test shall be performed with the test generator connected to each of the coupling and decoupling devices in turn, while the other non-excited RF input ports of the coupling devices are terminated by a 50-ohm load resistor.

The frequency range was swept from 150 kHz to 80 MHz, using the signal level established during the setting process and with a disturbance signal of 80 % amplitude. The signal was modulated with a 1 kHz sine wave, pausing to adjust the RF signal level or the switch coupling devices as necessary. The sweep rate was  $1.5 \times 10^{-3}$  decades/s. Where the frequency range is swept incrementally, the step size was 1 % of preceding frequency value from 150 kHz to 80 MHz.

The dwell time at each frequency was less than the time necessary for the EUT to be exercised, and able to respond. Sensitive frequencies such as clock frequency(ies) and harmonics or frequencies of dominant interest, was analyzed separately.

Attempts were made to fully exercise the EUT during testing, and to fully interrogate all exercise modes selected for susceptibility.

### 9.7.3. TEST SETUP

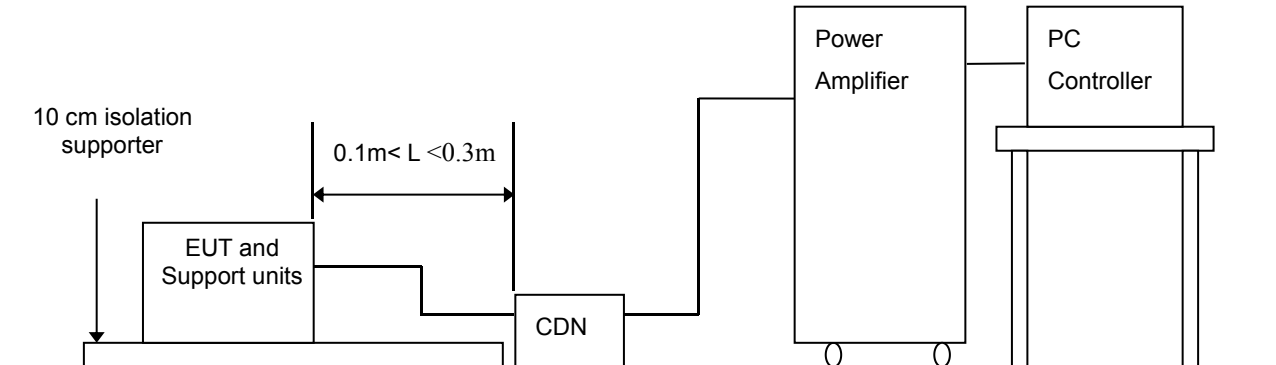

- Note:** 1. The EUT is setup 0.1m above Ground Reference Plane  
 2. The CDNS and / or EM clamp used for real test depends on ports and cables configuration of EUT.

For the actual test configuration, please refer to the related item.

**NOTE:**

TABLE-TOP AND FLOOR-STANDING EQUIPMENT

The equipment to be tested is placed on an insulating support of 0.1 meters height above a ground reference plane. All relevant cables shall be provided with the appropriate coupling and decoupling devices at a distance between 0.1 meters and 0.3 meters from the projected geometry of the EUT on the ground reference plane.

### 9.7.4. TEST RESULTS

Temperature ( °C )	22~28
Humidity ( %RH )	50~58
Barometric Pressure ( mbar )	950~1000
EUT	LED MAGNETIC TRACK LIGHTS
M/N	VT-4121
Operating Mode	Normal Operating
Test Results	PASS

Frequency Band (MHz)	Field Strength (Vrms)	Injected Position	Injection Method	Performance Criterion	Observation	Result
0.15 ~ 80	3	AC Mains	CDN-M3	A	Note <input checked="" type="checkbox"/> 1 <input type="checkbox"/> 2	PASS
0.15 ~ 80	3	N/A			Note <input type="checkbox"/> 1 <input type="checkbox"/> 2	N/A

- NOTE:** 1. There was no change compared with initial operation during the test.  
 2. The loss of function of the EUT during the test and it was recovered by itself operation after the test.



## 9.8. POWER FREQUENCY MAGNETIC FIELD

### 9.8.1. TEST SPECIFICATION

<b>Basic Standard:</b>	EN 61000-4-8
<b>Frequency Range:</b>	50Hz,
<b>Field Strength:</b>	3A/m
<b>Observation Time:</b>	5 minutes
<b>Inductance Coil:</b>	Rectangular type, 1mx1m
<b>Performance Criterion:</b>	A

### 9.8.2. TEST PROCEDURE

- a) The equipment is configured and connected to satisfy its functional requirements. It shall be placed on the GRP with the interposition of a 0.1m-thick insulating support.
- b. The equipment cabinets shall be connected to the safety earth directly on the GRP via the earth terminal of the EUT.
- c. The power supply, input and output circuits shall be connected to the sources of power supply, control and signal.
- d. The cables supplied or recommended by the equipment manufacturer shall be used. 1 meter of all cables used shall be exposed to the magnetic field.

### 9.8.3. TEST SETUP

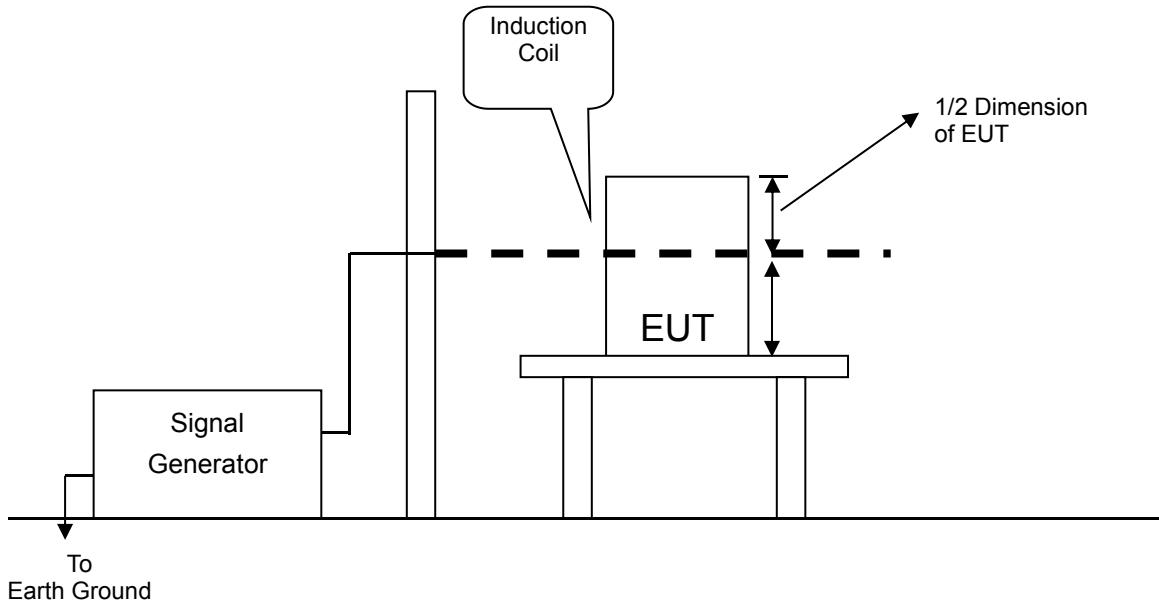

For the actual test configuration, please refer to the related item.

#### NOTE:

##### TABLETOP EQUIPMENT

The equipment shall be subjected to the test magnetic field by using the induction coil of standard dimension (1 m x 1 m). The induction coil shall then be rotated by 90 degrees in order to expose the EUT to the test field with different orientations.

##### FLOOR-STANDING EQUIPMENT

The equipment shall be subjected to the test magnetic field by using induction coils of suitable dimensions. The test shall be repeated by moving and shifting the induction coils, in order to test the whole volume of the EUT for each orthogonal direction. The test shall be repeated with the coil shifted to different positions along the side of the EUT, in steps corresponding to 50 % of the shortest side of the coil. The induction coil shall then be rotated by 90 degrees in order to expose the EUT to the test field with different orientations.

### 9.8.4. TEST RESULTS

Temperature ( °C )	22~28
Humidity ( %RH )	50~58
Barometric Pressure ( mbar )	950~1000
EUT	LED MAGNETICTRACK LIGHTS
M/N	VT-4121
Operating Mode	Normal Operating
Test Results	PASS

DIRECTION	Field Strength (A/m)	Performance Criterion	OBSERVATION	RESULTS
X	3	A	Note <input checked="" type="checkbox"/> 1 <input type="checkbox"/> 2	PASS
Y	3	A	Note <input checked="" type="checkbox"/> 1 <input type="checkbox"/> 2	PASS
Z	3	A	Note <input checked="" type="checkbox"/> 1 <input type="checkbox"/> 2	PASS

**NOTE:** 1. There was no change compared with initial operation during the test.  
 2. The loss of function of the EUT during the test and it was recovered by itself operation after the test.

## 9.9. VOLTAGE DIP & VOLTAGE INTERRUPTIONS

### 9.9.1. TEST SPECIFICATION

<b>Basic Standard:</b>	EN 61000-4-11
<b>Test Duration Time:</b>	Minimum three test events in sequence
<b>Interval Between Event:</b>	Minimum 10 seconds
<b>Phase Angle:</b>	0 / 45 / 90 / 135 / 180 / 225 / 270 / 315 / 360
<b>Test Cycle:</b>	3 times
<b>Performance Criterion:</b>	B,C

### 9.9.2. TEST PROCEDURE

1. The EUT and support units were located on a wooden table, 0.8 m away from ground floor.
2. Setting the parameter of tests and then perform the test software of test simulator.
3. Conditions changes to occur at 0 degree crossover point of the voltage waveform.
4. Recording the test result in test record form.

### 9.9.3. TEST SETUP

For the actual test configuration, please refer to the related item – Photographs of the Test Configuration.

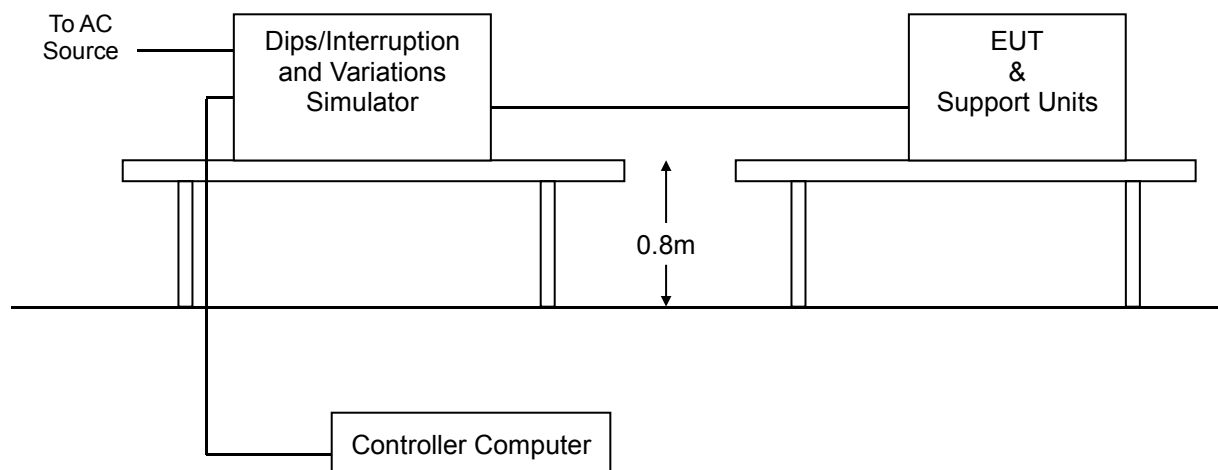

#### 9.9.4. TEST RESULTS

Temperature ( °C )	22~28
Humidity ( %RH )	50~58
Barometric Pressure ( mbar )	950~1000
EUT	LED MAGNETICTRACK LIGHTS
M/N	VT-4121
Operating Mode	Normal Operating
Test Results	PASS

Test Power: 230Vac, 50Hz				
Voltage (% Reduction)	Duration (Period)	Performance Criterion	Observation	Test Result
100	0.5	<input type="checkbox"/> A <input checked="" type="checkbox"/> B <input type="checkbox"/> C	Note <input type="checkbox"/> 1 <input checked="" type="checkbox"/> 2 <input type="checkbox"/> 3	PASS
30	10	<input type="checkbox"/> A <input type="checkbox"/> B <input checked="" type="checkbox"/> C	Note <input type="checkbox"/> 1 <input type="checkbox"/> 2 <input checked="" type="checkbox"/> 3	PASS

- NOTE:** 1. There was no change compared with initial operation during and after the test.  
 No unintentional response was found during the test.  
 2. The function stopped during the test, but can be recoverable by itself operation after the test.  
 3. The function stopped during the test, but can be recoverable manually after the test.

## 10. TEST SETUP PHOTOGRAPHS

### CONDUCTED EMISSION TEST

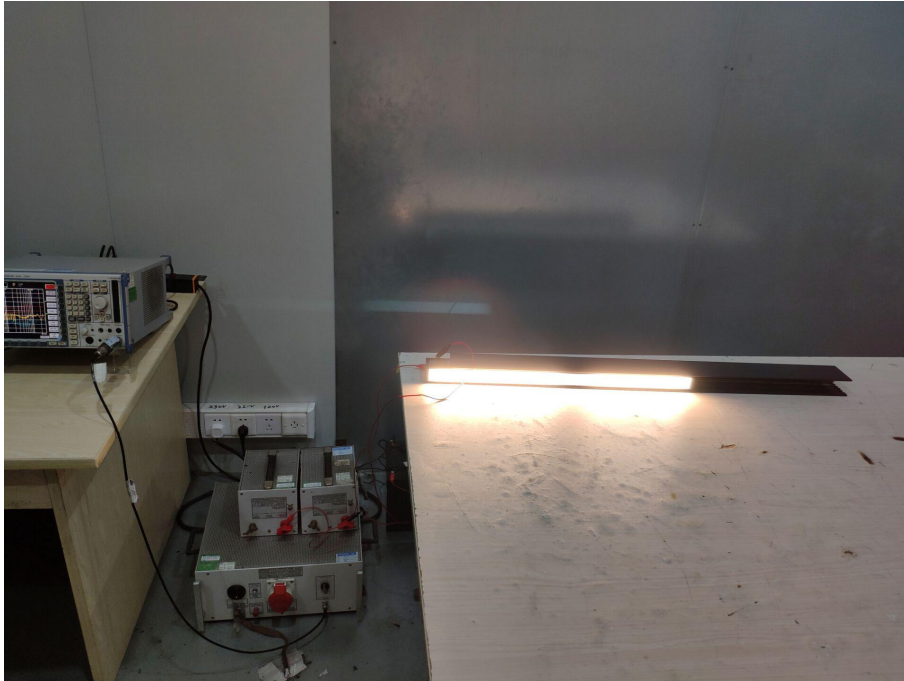

### RADIATED EMISSION TEST

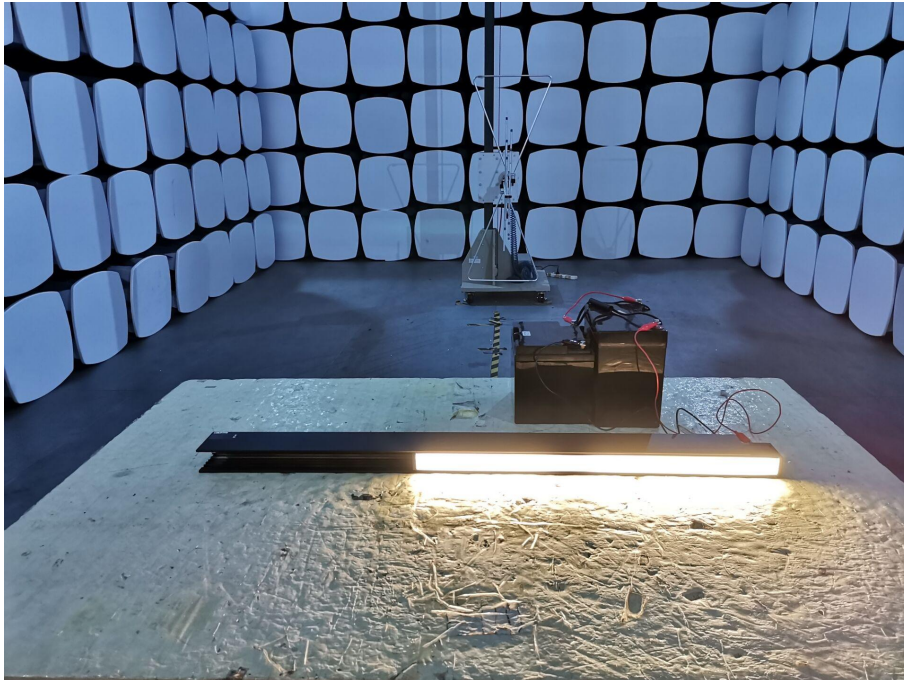

## 11. PHOTOGRAPHS OF EUT

<p>Photo 1</p> <p>View:</p> <p><input checked="" type="checkbox"/> Front</p> <p><input type="checkbox"/> Rear</p> <p><input type="checkbox"/> Right side</p> <p><input type="checkbox"/> Left side</p> <p><input type="checkbox"/> Top</p> <p><input type="checkbox"/> Bottom</p> <p><input type="checkbox"/> Internal</p>	
--	---

<p>Photo 2</p> <p>View:</p> <p><input checked="" type="checkbox"/> Front</p> <p><input type="checkbox"/> Rear</p> <p><input type="checkbox"/> Right side</p> <p><input type="checkbox"/> Left side</p> <p><input type="checkbox"/> Top</p> <p><input type="checkbox"/> Bottom</p> <p><input type="checkbox"/> Internal</p>	
--	--

<p>Photo 3</p> <p>View:</p> <p><input type="checkbox"/> Front</p> <p><input checked="" type="checkbox"/> Rear</p> <p><input type="checkbox"/> Right side</p> <p><input type="checkbox"/> Left side</p> <p><input type="checkbox"/> Top</p> <p><input type="checkbox"/> Bottom</p> <p><input type="checkbox"/> Internal</p>	
--	---

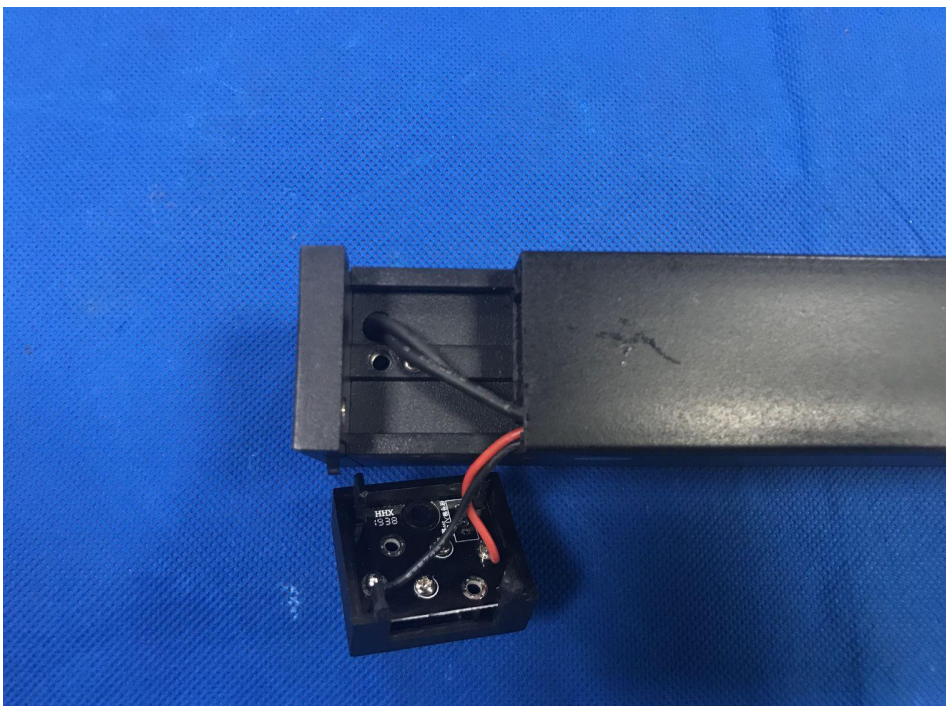
<p>Photo 4</p> <p>View:</p> <p><input type="checkbox"/> Front</p> <p><input type="checkbox"/> Rear</p> <p><input type="checkbox"/> Right side</p> <p><input type="checkbox"/> Left side</p> <p><input type="checkbox"/> Top</p> <p><input type="checkbox"/> Bottom</p> <p><input checked="" type="checkbox"/> Internal</p>	
--	--

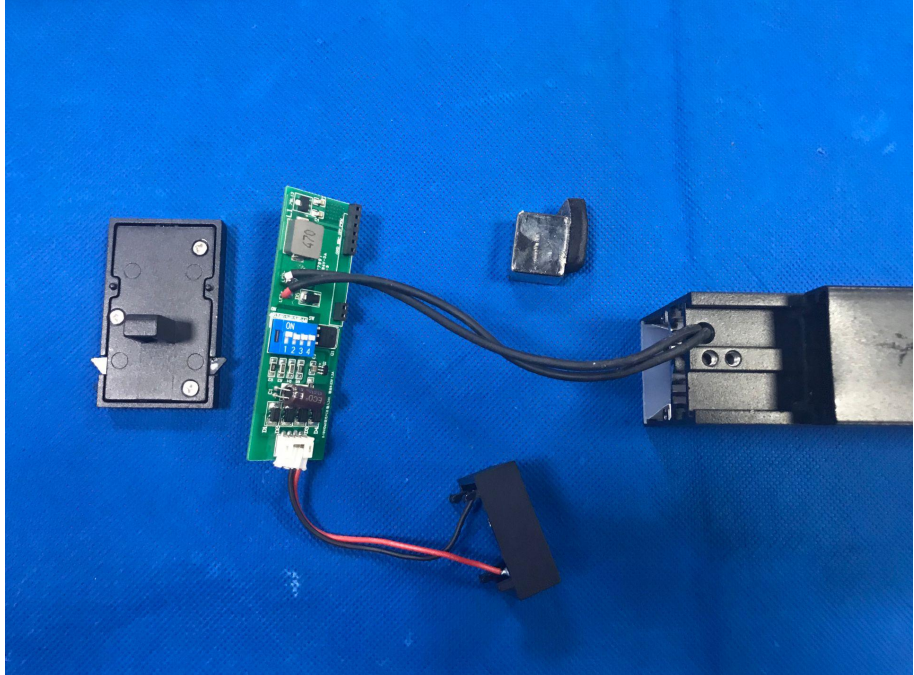

<p>Photo 5</p> <p>View:</p> <p><input type="checkbox"/> Front</p> <p><input type="checkbox"/> Rear</p> <p><input type="checkbox"/> Right side</p> <p><input type="checkbox"/> Left side</p> <p><input type="checkbox"/> Top</p> <p><input type="checkbox"/> Bottom</p> <p><input checked="" type="checkbox"/> Internal</p>	
--	--

<p>Photo 6</p> <p>View:</p> <p><input type="checkbox"/> Front</p> <p><input type="checkbox"/> Rear</p> <p><input type="checkbox"/> Right side</p> <p><input type="checkbox"/> Left side</p> <p><input type="checkbox"/> Top</p> <p><input type="checkbox"/> Bottom</p> <p><input checked="" type="checkbox"/> Internal</p>	
--	--

---END---