

EMC TEST REPORT

For

V-TAC EXPORTS LIMITED

Product Name: LED Ultraviolet Disinfection Lamp

Model No.: VT-3214

Prepared for : V-TAC EXPORTS LIMITED
Address : ROOM 301, KAM ON BUILDING 176A QUEENS ROAD
CENTRAL, CENTRAL, HONG KONG

Prepared by : SHENZHEN POCE TECHNOLOGY CO., LTD.
Address : H Building, Hongfa Science and Technology Park, Tangtou, Shiyuan,
Bao'an District, Shenzhen, China

Report No. : POCE200608042KRE
Date of Receiver : Jun. 02, 2020
Number of tested samples : 1
Date of Test : Jun. 02, 2020 – Jun. 08, 2020
Date of Report : Jun. 08, 2020

Note: This test report is limited to the above client company and the product model only. It may not be duplicated without prior written consent of Shenzhen POCE Technology Co., Ltd

TABLE OF CONTENT

Description

Test Report Description

Page

1. GENERAL INFORMATION	4
1.1. Description of Device (EUT)	4
1.2. Test Standards	5
1.3. Test Methodology	5
1.4. Test Facility	5
2. MEASURING DEVICE AND TEST EQUIPMENT	6
2.1. For Power Line Conducted Emission.....	6
2.2. For Radiated Emission Measurement.....	6
2.3. For Harmonic Current / Flicker Measurement.....	6
2.4. For Electrostatic Discharge Immunity Test	6
2.5. For RF Strength Susceptibility Test	7
2.6. For Electrical Fast Transient /Burst Immunity Test.....	7
2.7. For Surge Immunity Test.....	7
2.8. For Injected Current Susceptibility Test	7
2.9. For Voltage Dips and Interruptions Test	7
3. POWER LINE CONDUCTED EMISSION MEASUREMENT	8
3.1. Block Diagram of Test Setup.....	8
3.2. Measuring Standard	8
3.3. EUT Configuration on Measurement	8
3.4. Test Procedure	8
4. RADIATED EMISSION MEASUREMENT	9
4.1. Block Diagram of Test.....	9
4.2. Measuring Standard	9
4.3. EUT Configuration on Test	9
4.4. Test Procedure	10
5. HARMONIC CURRENT EMISSION MEASUREMENT	13
5.1 Block Diagram of Test Setup.....	13
5.2 Measuring Standard	13
5.3 Description of test Equipment.....	13
6. VOLTAGE FLUCTUATION AND FLICKER MEASUREMENT	14
6.1 Block Diagram of Test Setup.....	14
6.2 Measuring Standard	14
7. ELECTROSTATIC DISCHARGE IMMUNITY TEST.....	15
7.1 Block Diagram of Test Setup	15
7.2 Test Standard	15
7.3 Severity Levels and Performance Criterion.....	15
7.4 Test Procedure	16
8. RF FIELD STRENGTH SUSCEPTIBILITY TEST.....	18
8.1 Block Diagram of Test.....	18
8.2 Test Standard.....	18
8.3 Severity Levels and Performance Criterion	19
8.4 Test Procedure	19
9. ELECTRICAL FAST TRANSIENT/BURST IMMUNITY TEST	21
9.1 Block Diagram of Test Setup	21
9.2 Test Standard	21
9.3 Severity Levels and Performance Criterion.....	21
9.4 Test Procedure	22

10. SURGE IMMUNITY TEST	23
10.1 Block Diagram of Test Setup	23
10.2 Test Standard	23
10.3 Severity Levels and Performance Criterion	23
10.4 Test Procedure	23
11. INJECTED CURRENTS SUSCEPTIBILITY TEST	24
11.1 Block Diagram of Test Setup	24
11.2 Test Standard	24
11.3 Severity Levels and Performance Criterion	24
11.4 Test Procedure	25
12. VOLTAGE DIPS AND INTERRUPTIONS TEST	26
12.1 Block Diagram of Test Setup	26
12.2 Test Standard	26
12.3 Severity Levels and Performance Criterion	27
12.4 Test Procedure	27
13. Test Photo	28
13.1 Photo of Radiated Emission Measurement	28
14. PHOTOGRAPHS OF EUT	29
15. MANUFACTURER/ APPROVAL HOLDER DECLARATION.....	34

1. GENERAL INFORMATION

1.1. Description of Device (EUT)

EUT : LED Ultraviolet Disinfection Lamp

Trade Name : 

Model : VT-3214

Supplementary Model : N/A

Test Voltage : Form Battery DC 3.7V

Rating : Form Battery DC 3.7V

Applicant : V-TAC EXPORTS LIMITED

Address : ROOM 301, KAM ON BUILDING 176A QUEENS ROAD
CENTRAL, CENTRAL, HONG KONG

Manufacturer : Shenzhen Xingzhiyou Technology Co., Ltd

Address : 3F, No.2 Building, 328 Industrial Zone, No.19 Dakang Road,
Henggang street, Longgang Distrcit, Shenzhen

Test Standards : EN 55014-1:2017
EN 55014-2:2015
EN61000-3-2: 2019
EN 61000-3-3:2013+A1:2019

Test Result : PASS

Test Engineer : 

Reviewed By : 

1.2. Test Standards

- √ Indicates that the test is applicable
- × Indicates that the test is not applicable

Standard	Test Items	Status
EN 55014-1:2017	Disturbance Voltage at The Mains Terminals (150KHz To 30MHz)	×
	Radiated Disturbances (30MHz To 1000MHz)	√
EN61000-3-2:2019	Harmonic Current	×
EN61000-3-3:2013+A1:2019	Voltage Fluctuations	×
EN61000-4-2:2009	Electrostatic discharge Immunity	√
EN61000-4-3: 2006/A2:2010	Radiated Susceptibility (80MHz to 1GHz)	√
EN61000-4-4:2012	Electrostatic Fast Transient/Burst Immunity	×
EN61000-4-5:2014/A1:2017	Surge Immunity	×
EN61000-4-6:2014/AC:2015	Conducted Susceptibility (150KHz to 230MHz)	×
EN61000-4-11:2004AC:2017	Voltage Dips Short Interruptions Immunity Tests	×

1.3. Test Methodology

All measurements contained in this report were conducted with CISPR 16-1, radio disturbance and immunity measuring apparatus, and CISPR16-2, Method of measurement of disturbances and immunity.

All measurement required was performed at laboratory of Shenzhen POCE Technology Co., Ltd., at H Building, Hongfa Science and Technology Park, Tangtou, Shiyan, Bao'an District, Shenzhen, China

1.4. Test Facility

The test facility is recognized, certified, or accredited by the following organizations:

CNAS Registration Number. is L8229

The facility also complies with the radiated and AC line conducted test site criteria set forth in CISPR 16-1, CISPR16-2.

2. MEASURING DEVICE AND TEST EQUIPMENT

2.1. For Power Line Conducted Emission

Item	Equipment	Manufacturer	Model No.	Factory Number	Last Cal.
1.	Test Receiver	Rohde & Schwarz	ESPI TEST RECEIVER	ID:1164.6607K03-102109-MH	Dec. 11, 2019
2.	L.I.S.N	Rohde & Schwarz	ESH3-Z5.831.5518.52	9561-G071	Dec. 11, 2019
3.	50ΩCoaxial Switch	Anritsu	MP59B	M20531	N/A
4.	Pulse Limiter	SCHWARZ BECK	VTSD 9561-F Pulse limiter 10dB Ateennator	561-G071	Dec. 11, 2019
5.	Cable	SCHWARZ BECK	N/A	N/A	Dec. 11, 2019

2.2. For Radiated Emission Measurement

Item	Equipment	Manufacturer	Model No.	Factory Number	Last Cal.
1.	Test Receiver	Rohde & Schwarz	ESPI TEST RECEIVER	ID:1164.6607K03-102109-MH	Dec. 11, 2019
2.	Bilog Antenna	Sunol Sciences	Model JB6 Antenna	A090414	Dec. 11, 2019
3.	50ΩCoaxial Switch	Anritsu	MP59B	M20531	N/A
4.	control	Positioning Controller	Model MF-7802	MF780208362	Dec. 11, 2019
5.	Cable	SCHWARZ BECK	N/A	N/A	Dec. 11, 2019
6.	Cable	SCHWARZ BECK	N/A	N/A	Dec. 11, 2019

2.3. For Harmonic Current / Flicker Measurement

Item	Equipment	Manufacturer	Model No.	Factory Number	Last Cal.
1.	Coupling decoupling network	SCHAFFNER	M016	20812	Dec. 11, 2019
2.	PC	N/A	P2L97	N/A	Dec. 11, 2019

2.4. For Electrostatic Discharge Immunity Test

Item	Equipment	Manufacturer	Model No.	Factory Number	Last Cal.
1.	ESD Tester	Prima	ESD61002A	144305	Dec. 11, 2019

2.5. For RF Strength Susceptibility Test

Item	Equipment	Manufacturer	Model No.	Factory Number	Last Cal.
1.	Signal Generator	HP	8648A	3625U00573	Dec. 11, 2019
2.	Amplifier	AR	500A100	17034	NCR
3.	Amplifier	AR	100W/1000M1	17028	NCR
4.	Isotropic Field Monitor	AR	FM2000	16829	NCR
5.	Isotropic Field Probe	AR	FP2000	16755	Dec. 11, 2019
6.	Biconic Antenna	EMCO	3108	9507-2534	NCR
7.	Log-periodic Antenna	AR	AT1080	16812	NCR
8.	PC	N/A	486DX2	N/A	N/A

2.6. For Electrical Fast Transient /Burst Immunity Test

Item	Equipment	Manufacturer	Model No.	Factory Number	Last Cal.
1.	Burst Tester	HTEC	HEFT 51	144303	Dec. 11, 2019
2.	Coupling Clamp	HTEC	IP-4A	147147	Dec. 11, 2019

2.7. For Surge Immunity Test

Item	Equipment	Manufacturer	Model No.	Factory Number	Last Cal.
1.	Surge Tester	HTEC	HCWG	144302	Dec. 11, 2019

2.8. For Injected Current Susceptibility Test

Item	Equipment	Manufacturer	Model No.	Factory Number	Last Cal.
1.	Simulator	EMTEST	CWS500C	0900-12	Dec. 11, 2019
2.	CDN	EMTEST	CDN-M2	5VT-321400100	Dec. 11, 2019
3.	CDN	EMTEST	CDN-M3	0900-11	Dec. 11, 2019
4.	Injection Clamp	EMTEST	F-2031-23MM	368	Dec. 11, 2019
5.	Attenuator	EMTEST	ATT6	0010222A	Dec. 11, 2019

2.9. For Voltage Dips and Interruptions Test

Item	Equipment	Manufacturer	Model No.	Factory Number	Last Cal.
1.	Dips Tester	HTEC	HPFS	144304	Dec. 11, 2019

3. POWER LINE CONDUCTED EMISSION MEASUREMENT

3.1. Block Diagram of Test Setup

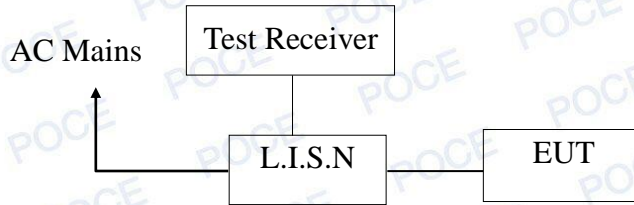

(EUT: LED Ultraviolet Disinfection Lamp)

3.2. Measuring Standard

EN 55014-1:2017

Power Line Conducted Emission Limits

Frequency (MHz)	Limit (dBμV)	
	Quasi-Peak Level	Average Level
0.15 ~ 0.50	66.0 ~ 56.0 *	59.0 ~ 46.0 *
0.50 ~ 5.00	56.0	46.0
5.00 ~ 30.00	60.0	50.0

NOTE1-The lower limit shall apply at the transition frequencies.
 NOTE2-The limit decreases linearly with the logarithm of the frequency in the range 0.15MHz to 0.50MHz.

3.3. EUT Configuration on Measurement

The following equipments are installed on Conducted Emission Measurement to meet EN55014 requirements and operating in a manner which tends to maximize its emission characteristics in a normal application.

3.4. Test Procedure

The EUT is put on the plane 0.8m high above the ground by insulating support and connected to the AC mains through Line Impedance Stability Network (L.I.S.N). This provided a 50ohm coupling impedance for the tested equipments. Both sides of AC line are investigated to find out the maximum conducted emission according to the EN55014 regulations during conducted emission measurement.

The bandwidth of the field strength meter (R&S Test Receiver ESVT-3214) is set at 9KHz in 150KHz~30MHz and 200Hz in 9KHz~150KHz.

The frequency range from 150kHz to 30MHz is investigated.

Conduction Uncertainty: $U_c = \pm 2.72 \text{ dB}$

4. RADIATED EMISSION MEASUREMENT

4.1. Block Diagram of Test

4.1.1. Block diagram of test setup (In chamber)

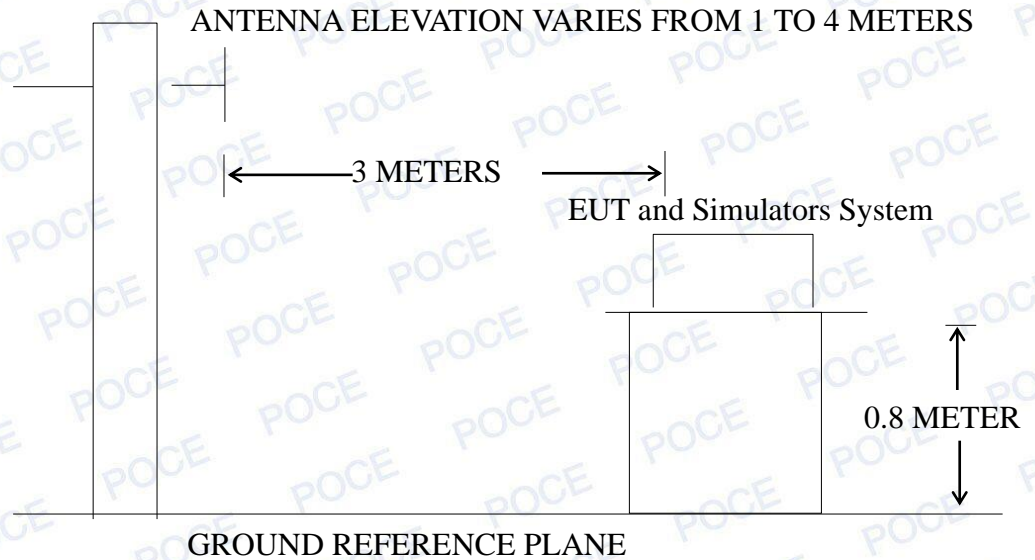

(EUT: LED Ultraviolet Disinfection Lamp)

4.2. Measuring Standard

EN 55014-1:2017

Radiated Emission Limits

including any network of conductors and apparatus connected thereto, shall not exceed the level of field strengths specified below:

FREQUENCY (MHz)	DISTANCE (Meters)	FIELD STRENGTHS LIMIT (dB μ V/m)
30 ~ 230	3	40
230 ~ 1000	3	47

Note: (1) The smaller limit shall apply at the combination point between two frequency bands.

(2) Distance refers to the distance in meters between the measuring instrument antenna and the closed point of any part of the EUT.

4.3. EUT Configuration on Test

The EN55014 regulations test method must be used to find the maximum emission during radiated emission measurement.

4.4. Test Procedure

The EUT is placed on a turn table which is 0.8 meter high above the ground. The turn table can rotate 360 degrees to determine the position of the maximum emission level. The EUT is set 3 meters away from the receiving antenna which is mounted on a antenna tower. The antenna can be moved up and down from 1 to 4 meters to find out the maximum emission level. Bilog antenna (calibrated by Dipole Antenna) is used as a receiving antenna. Both horizontal and vertical polarization of the antenna are set on test.

The bandwidth of the Receiver (ESVT-3214) is set at 120kHz.
The frequency range from 30MHz to 1000MHz is investigated.

Radiation Uncertainty: $U_r = \pm 3.84$ dB

Radiated Emission Test Data

EUT	: LED Ultraviolet Disinfection Lamp	Temperature:	20°C
M/N	: VT-3214	Humidity	: 50%
Test Voltage	: Form Battery DC 3.7V	Test Mode	: On
Test Engineer	: Bill	Polarization	: Horizontal

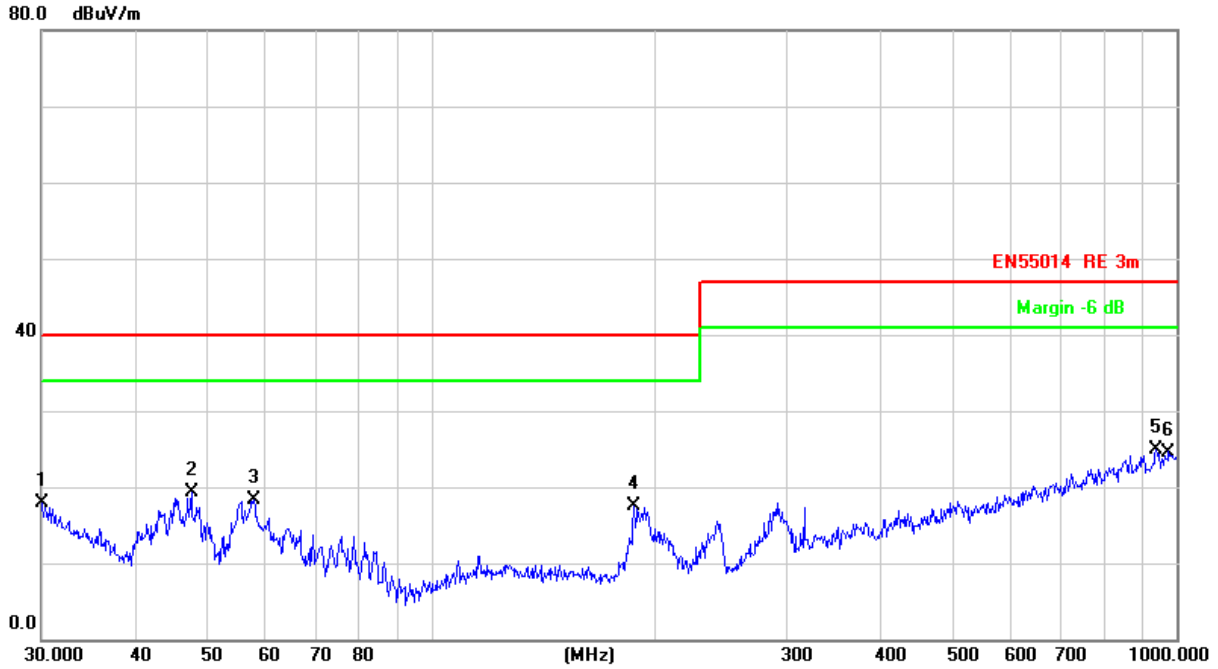

No.	Mk.	Freq.	Reading Level	Correct Factor	Measurement	Limit	Over	Antenna Height	Table Degree	
		MHz	dBuV	dB/m	dBuV/m	dBuV/m	dB	cm	degree	Comment
1		30.0000	21.41	-3.50	17.91	40.00	-22.09	QP		
2	*	47.6586	35.87	-16.65	19.22	40.00	-20.78	QP		
3		57.7962	37.13	-18.88	18.25	40.00	-21.75	QP		
4		187.0958	31.84	-14.40	17.44	40.00	-22.56	QP		
5		938.8326	24.02	0.82	24.84	47.00	-22.16	QP		
6		975.7529	23.41	1.19	24.60	47.00	-22.40	QP		

Radiated Emission Test Data

EUT	: LED Ultraviolet Disinfection Lamp	Temperature:	20°C
M/N	: VT-3214	Humidity	: 50%
Test Voltage	: Form Battery DC 3.7V	Test Mode	: On
Test Engineer	: Bill	Polarization	: Vertical

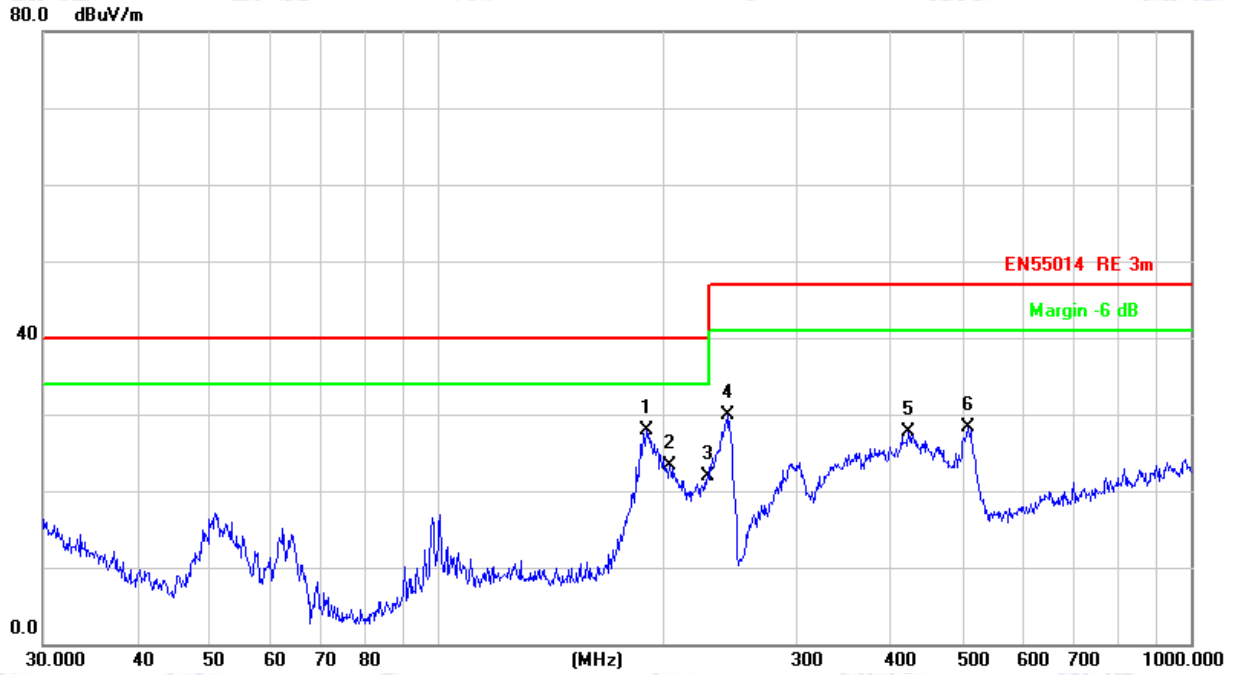

No.	Mk.	Freq.	Reading Level	Correct Factor	Measurement	Limit	Over	Antenna Height	Table Degree	
		MHz	dBuV	dB/m	dBuV/m	dBuV/m	dB	cm	degree	Comment
1	*	189.7384	42.30	-14.37	27.93	40.00	-12.07	QP		
2		203.5227	36.74	-13.50	23.24	40.00	-16.76	QP		
3		228.4903	35.88	-13.98	21.90	40.00	-18.10	QP		
4		242.5252	43.04	-13.22	29.82	47.00	-17.18	QP		
5		422.0577	36.04	-8.34	27.70	47.00	-19.30	QP		
6		506.4791	34.59	-6.36	28.23	47.00	-18.77	QP		

5. HARMONIC CURRENT EMISSION MEASUREMENT

5.1 Block Diagram of Test Setup

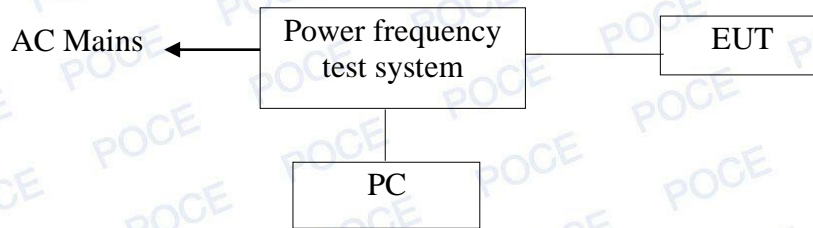

(EUT: LED Ultraviolet Disinfection Lamp)

5.2 Measuring Standard

EN 61000-3-2: 2019

5.3 Description of test Equipment

Note: Equipment is less than 75W, no corresponding harmonic current limit.

6. VOLTAGE FLUCTUATION AND FLICKER MEASUREMENT

6.1 Block Diagram of Test Setup

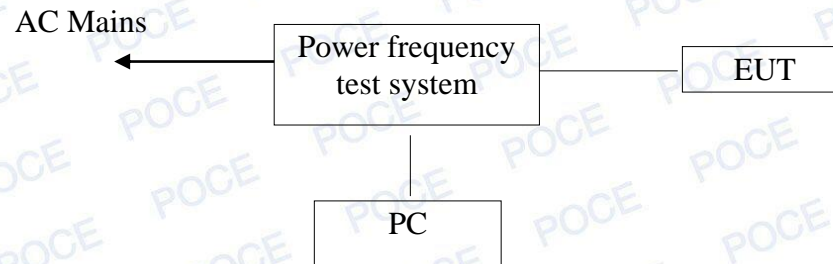

(EUT: LED Ultraviolet Disinfection Lamp)

6.2 Measuring Standard

EN61000-3-3:2013+A1:2019

7. ELECTROSTATIC DISCHARGE IMMUNITY TEST

7.1 Block Diagram of Test Setup

7.1.1 Block Diagram of the EUT and the simulators

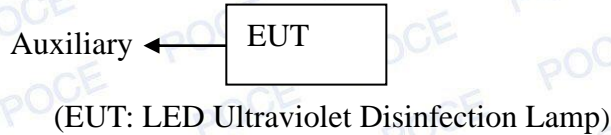

7.1.2 Block diagram of ESD test setup

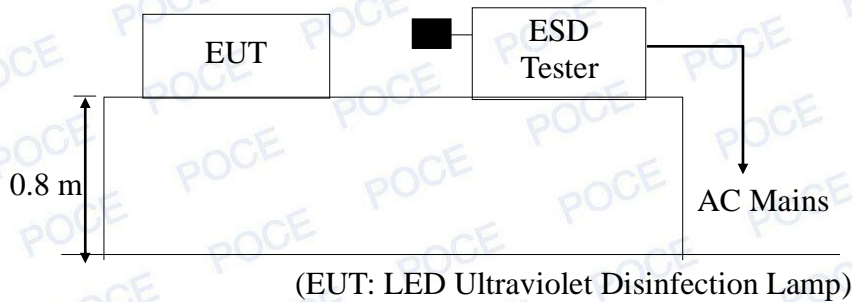

7.2 Test Standard

EN 55014-2:2015(EN61000-4-2: 2009)

Severity Level: 3 / Air Discharge: ±8KV Level: 2 / Contact Discharge: ±4KV)

7.3 Severity Levels and Performance Criterion

7.3.1 Severity level

Level	Test Voltage Contact Discharge (KV)	Test Voltage Air Discharge (KV)
1.	±2	±2
2.	±4	±4
3.	±6	±8
4.	±8	±15
X	Special	Special

7.3.2 Performance criterion: **B**

7.4 Test Procedure

7.4.1 Air Discharge:

This test is done on a non-conductive surface. The round discharge tip of the discharge electrode shall be approached as fast as possible to touch the EUT. After each discharge, the discharge electrode shall be removed from the EUT. The generator is then re-triggered for a new single discharge and repeated 10 times for each pre-selected test point. This procedure shall be repeated until all the air discharge completed.

7.4.2 Contact Discharge:

All the procedure shall be same as Section 7.4.1. except that the tip of the discharge electrode shall touch the EUT before the discharge switch is operated.

7.4.3 Indirect discharge for horizontal coupling plane

At least 10 single discharges (in the most sensitive polarity) shall be applied at the front edge of each HCP opposite the center point of each unit (if applicable) of the EUT and 0.1m from the front of the EUT. The long axis of the discharge electrode shall be in the plane of the HCP and perpendicular to its front edge during the discharge.

7.4.4 Indirect discharge for vertical coupling plane

At least 10 single discharge (in the most sensitive polarity) shall be applied to the center of one vertical edge of the coupling plane. The coupling plane, of dimensions 0.5m X 0.5m, is placed parallel to, and positioned at a distance of 0.1m from the EUT. Discharges shall be applied to the coupling plane, with this plane in sufficient different positions that the four faces of the EUT are completely illuminated.

Electrostatic Discharger Test Results

Standard	<input type="checkbox"/> IEC 61000-4-2 <input checked="" type="checkbox"/> EN 61000-4-2		
EUT	LED Ultraviolet Disinfection Lamp	Temperature	24°C
M/N	VT-3214	Humidity	53%
Criterion	B	Pressure	1021mbar
Test Mode	Normal	Test Date	2020-06-06
Test Engineer	Bill		

Air Discharge

Test Points	Test Levels			Results		
	± 2KV	± 4KV	± 8KV	Passed	Fail	Performance Criterion
Front	<input checked="" type="checkbox"/>	<input checked="" type="checkbox"/>	<input checked="" type="checkbox"/>	<input checked="" type="checkbox"/>	<input type="checkbox"/>	<input type="checkbox"/> A <input checked="" type="checkbox"/> B
Back	<input checked="" type="checkbox"/>	<input checked="" type="checkbox"/>	<input checked="" type="checkbox"/>	<input checked="" type="checkbox"/>	<input type="checkbox"/>	<input type="checkbox"/> A <input checked="" type="checkbox"/> B
Left	<input checked="" type="checkbox"/>	<input checked="" type="checkbox"/>	<input checked="" type="checkbox"/>	<input checked="" type="checkbox"/>	<input type="checkbox"/>	<input type="checkbox"/> A <input checked="" type="checkbox"/> B
Right	<input checked="" type="checkbox"/>	<input checked="" type="checkbox"/>	<input checked="" type="checkbox"/>	<input checked="" type="checkbox"/>	<input type="checkbox"/>	<input type="checkbox"/> A <input checked="" type="checkbox"/> B
Top	<input checked="" type="checkbox"/>	<input checked="" type="checkbox"/>	<input checked="" type="checkbox"/>	<input checked="" type="checkbox"/>	<input type="checkbox"/>	<input type="checkbox"/> A <input checked="" type="checkbox"/> B
Bottom	<input checked="" type="checkbox"/>	<input checked="" type="checkbox"/>	<input checked="" type="checkbox"/>	<input checked="" type="checkbox"/>	<input type="checkbox"/>	<input type="checkbox"/> A <input checked="" type="checkbox"/> B

Contact Discharge

Test Points	Test Levels		Results		
	± 2 kV	±4 kV	Passed	Fail	Performance Criterion
Front	<input checked="" type="checkbox"/>	<input checked="" type="checkbox"/>	<input checked="" type="checkbox"/>	<input type="checkbox"/>	<input type="checkbox"/> A <input checked="" type="checkbox"/> B
Back	<input checked="" type="checkbox"/>	<input checked="" type="checkbox"/>	<input checked="" type="checkbox"/>	<input type="checkbox"/>	<input type="checkbox"/> A <input checked="" type="checkbox"/> B
Left	<input checked="" type="checkbox"/>	<input checked="" type="checkbox"/>	<input checked="" type="checkbox"/>	<input type="checkbox"/>	<input type="checkbox"/> A <input checked="" type="checkbox"/> B
Right	<input checked="" type="checkbox"/>	<input checked="" type="checkbox"/>	<input checked="" type="checkbox"/>	<input type="checkbox"/>	<input type="checkbox"/> A <input checked="" type="checkbox"/> B
Top	<input checked="" type="checkbox"/>	<input checked="" type="checkbox"/>	<input checked="" type="checkbox"/>	<input type="checkbox"/>	<input type="checkbox"/> A <input checked="" type="checkbox"/> B
Bottom	<input checked="" type="checkbox"/>	<input checked="" type="checkbox"/>	<input checked="" type="checkbox"/>	<input type="checkbox"/>	<input type="checkbox"/> A <input checked="" type="checkbox"/> B

Discharge To Horizontal Coupling Plane

Side of EUT	Test Levels		Results		
	± 2 kV	± 4 kV	Passed	Fail	Performance Criterion
Front	<input checked="" type="checkbox"/>	<input checked="" type="checkbox"/>	<input checked="" type="checkbox"/>	<input type="checkbox"/>	<input type="checkbox"/> A <input checked="" type="checkbox"/> B
Back	<input checked="" type="checkbox"/>	<input checked="" type="checkbox"/>	<input checked="" type="checkbox"/>	<input type="checkbox"/>	<input type="checkbox"/> A <input checked="" type="checkbox"/> B
Left	<input checked="" type="checkbox"/>	<input checked="" type="checkbox"/>	<input checked="" type="checkbox"/>	<input type="checkbox"/>	<input type="checkbox"/> A <input checked="" type="checkbox"/> B
Right	<input checked="" type="checkbox"/>	<input checked="" type="checkbox"/>	<input checked="" type="checkbox"/>	<input type="checkbox"/>	<input type="checkbox"/> A <input checked="" type="checkbox"/> B

Discharge To Vertical Coupling Plane

Side of EUT	Test Levels		Results		
	± 2 kV	± 4 kV	Passed	Fail	Performance Criterion
Front	<input checked="" type="checkbox"/>	<input checked="" type="checkbox"/>	<input checked="" type="checkbox"/>	<input type="checkbox"/>	<input type="checkbox"/> A <input checked="" type="checkbox"/> B
Back	<input checked="" type="checkbox"/>	<input checked="" type="checkbox"/>	<input checked="" type="checkbox"/>	<input type="checkbox"/>	<input type="checkbox"/> A <input checked="" type="checkbox"/> B
Left	<input checked="" type="checkbox"/>	<input checked="" type="checkbox"/>	<input checked="" type="checkbox"/>	<input type="checkbox"/>	<input type="checkbox"/> A <input checked="" type="checkbox"/> B
Right	<input checked="" type="checkbox"/>	<input checked="" type="checkbox"/>	<input checked="" type="checkbox"/>	<input type="checkbox"/>	<input type="checkbox"/> A <input checked="" type="checkbox"/> B

8. RF FIELD STRENGTH SUSCEPTIBILITY TEST

8.1 Block Diagram of Test

8.1.1 Block diagram of connection between the EUT and Load

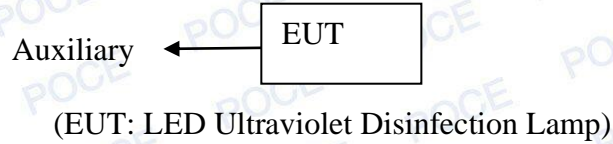

8.1.2 Block diagram of RS test setup

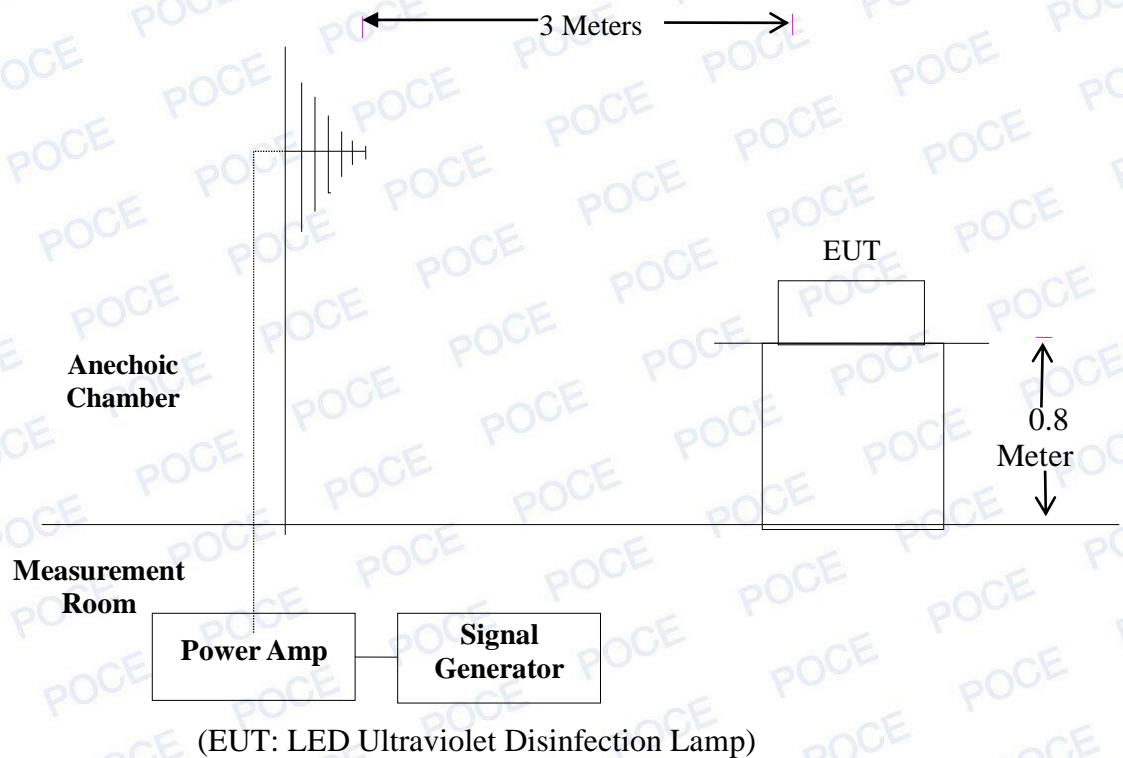

8.2 Test Standard

EN 55014-2:2015(EN61000-4-3: 2006/A2:2010 (Severity Level: 2, 3V / m))

8.3 Severity Levels and Performance Criterion

8.3.1 Severity Levels

Level	Field Strength V/m
1.	1
2.	3
3.	10
X	Special

8.3.2 Performance Criterion: A

8.4 Test Procedure

The EUT are placed on a table which is 0.8 meter high above the ground. The EUT is set 3 meters away from the transmitting antenna which is mounted on an antenna tower. Both horizontal and vertical polarization of the antenna are set on test. Each of the four sides of the EUT must be faced this transmitting antenna and measured individually. In order to judge the EUT performance, a CCD camera is used to monitor its screen.

All the scanning conditions are as following:

Condition of Test	Remark
1. Fielded Strength	3V/m (Severity Level 2)
2. Radiated Signal	Modulated
3. Scanning Frequency	80-1000MHz
4. Sweep time of radiated	0.0015 Decade/s
5. Dwell Time	1 Sec.

RF Field Strength Susceptibility Test Results

EUT	: LED Ultraviolet Disinfection Lamp	Temperature	: 22°C
M/N	: VT-3214	Humidity	: 50 %
Test Voltage	: Form Battery DC 3.7V	Test Mode	: On
Field Strength	: 3 V/m	Test Date	: 2020-06-06
Test Engineer:	Bill	Frequency Range:	80 MHz to 1000 MHz
Modulation:	<input type="checkbox"/> None	<input type="checkbox"/> Pulse	<input checked="" type="checkbox"/> AM 1KHz 80%
	Frequency Rang 1: 80~ 1000MHz	Frequency Rang 2:	
Steps	1 / %	# / %	
	Horizontal	Vertical	Horizontal Vertical
Front	PASS	PASS	
Right	PASS	PASS	
Rear	PASS	PASS	
Left	PASS	PASS	
Test Equipment : 1. Signal Generator : 2031 (MARCONI) 2. Power Amplifier : 500A100 & 100W/1000M1 (A&R) 3. Power Antenna : 3108 (EMCO) & AT1080 (A&R) 4. Field Monitor : FM2000 (A&R)			
Note: Note: (The Criterion) A: Normal performance within the specification limits; B: Temporary degradation or less of function or performance which is self-recoverable; C: Temporary degradation or loss of function or performance which requires operator intervention or system reset;			

9. ELECTRICAL FAST TRANSIENT/BURST IMMUNITY TEST

9.1 Block Diagram of Test Setup

9.1.1. Block Diagram of the EUT

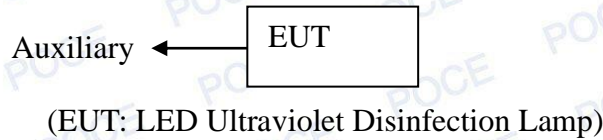

9.1.2. EFT Test Setup

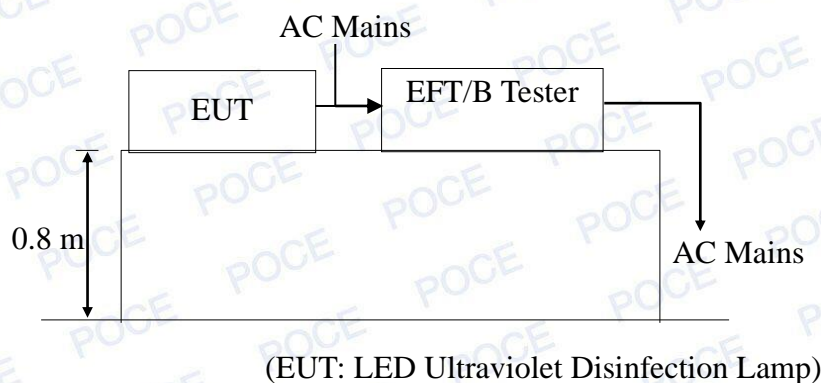

9.2 Test Standard

EN 55014-2:2015(EN61000-4-4:2012, Severity Level, Level 2: 1KV)

9.3 Severity Levels and Performance Criterion

9.3.1 Severity level

Level	Open Circuit Output Test Voltage $\pm 10\%$	
	On Power Supply Lines	On I/O (Input/Output) Signal data and control lines
1.	0.5 KV	0.25 KV
2.	1 KV	0.5 KV
3.	2 KV	1 KV
4.	4 KV	2 KV
X	Special	Special

9.3.2 Performance criterion: **B**

9.4 Test Procedure

The EUT is put on the table which is 0.8 meter high above the ground. This reference ground plane shall project beyond the EUT by at least 0.1m on all sides and the minimum distance between EUT and all other conductive structure, except the ground plane beneath the EUT, shall be more than 0.5m.

9.4.1 For input and output AC power ports:

The EUT is connected to the power mains by using a coupling device which couples the EFT interference signal to AC power lines. Both polarities of the test voltage should be applied during compliance test and the duration of the test is 2 mins.

9.4.2 For signal lines and control lines ports:

No I/O ports. It's unnecessary to test.

9.4.3 For DC output line ports:

It's unnecessary to test.

10. SURGE IMMUNITY TEST

10.1 Block Diagram of Test Setup

10.1.1 Block Diagram of the EUT



10.1.2. Surge Test Setup

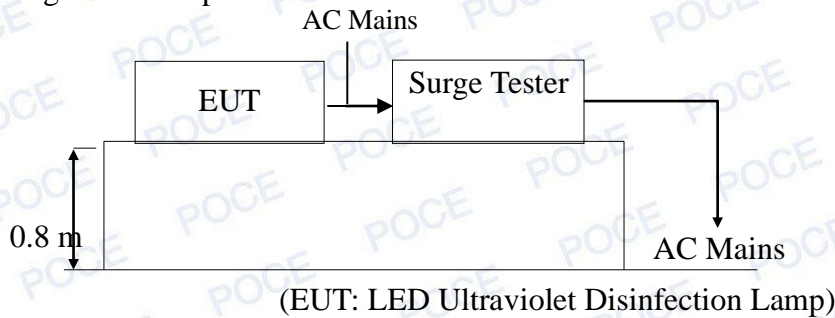

10.2 Test Standard

EN 55014-2:2015 (EN61000-4-5: 2014/A1:2017) Severity Level: Line to Line: Level 2, 1.0KV

10.3 Severity Levels and Performance Criterion

10.3.1. Severity level

Severity Level	Open-Circuit Test Voltage KV
1	0.5
2	1.0
3	2.0
4	4.0
*	Special

10.3.2 Performance criterion: **B**

10.4 Test Procedure

- 1) Set up the EUT and test generator as shown on Section 10.1.2.
- 2) For line to line coupling mode, provide a 1.0 KV 1.2/50us voltage surge (at open-circuit condition) and 8/20us current surge to EUT selected points.
- 3) At least 5 positive and 5 negative (polarity) tests with a maximum 1/min repetition rate are conducted during test.
- 4) Different phase angles are done individually.
- 5) Record the EUT operating situation during compliance test and decide the EUT immunity criterion for above each test.

11. INJECTED CURRENTS SUSCEPTIBILITY TEST

11.1 Block Diagram of Test Setup

11.1.1 Block Diagram of the EUT



(EUT: LED Ultraviolet Disinfection Lamp)

11.1.2 Block Diagram of Test Setup

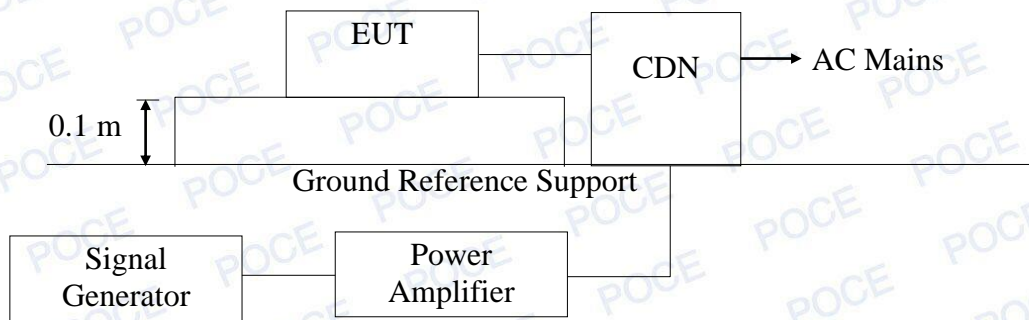

(EUT: LED Ultraviolet Disinfection Lamp)

11.2 Test Standard

EN 55014-2:2015(EN61000-4-6: 2014/AC:2015, Severity Level: Level 2, 3V (rms), (0.15MHz ~ 80MHz)

11.3 Severity Levels and Performance Criterion

11.3.1 Severity level

Level	Field Strength V
1	1
2	3
3	10
X	Special

11.3.2 Performance criterion: A

11.4 Test Procedure

- 1) Set up the EUT, CDN and test generators as shown on Section 11.1.2.
- 2) Let the EUT work in test mode and measure it.
- 3) The EUT are placed on an insulating support 0.1m high above a ground reference plane. CDN (coupling and decoupling device) is placed on the ground plane about 0.3m from EUT. Cables between CDN and EUT are as short as possible, and their height above the ground reference plane shall be between 30 and 50 mm (where possible).
- 4) The disturbance signal described below is injected to EUT through CDN.
- 5) The EUT operates within its operational mode(s) under intended climatic conditions after power on.
- 6) The frequency range is swept from 150KHz to 80MHz using 3V signal level, and with the disturbance signal 80% amplitude modulated with a 1KHz sine wave.
- 7) The rate of sweep shall not exceed 1.5×10^{-3} decades/s. Where the frequency is swept incrementally, the step size shall not exceed 1% of the start and thereafter 1% of the preceding frequency value.
- 8) Recording the EUT operating situation during compliance testing and decide the EUT immunity criterion.

12. VOLTAGE DIPS AND INTERRUPTIONS TEST

12.1 Block Diagram of Test Setup

12.1.1 Block Diagram of the EUT

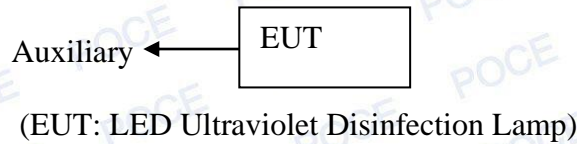

12.1.2 Dips Test Setup

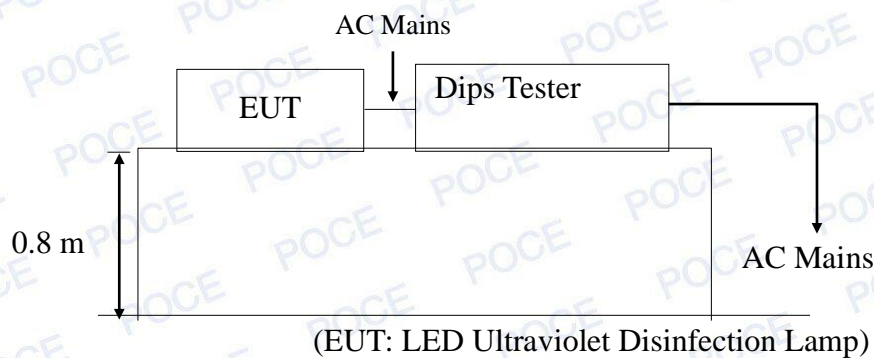

12.2 Test Standard

EN 55014-2:2015(EN61000-4-11: 2004/AC:2017)

12.3 Severity Levels and Performance Criterion

12.3.1 Severity level

Test Level %UT	Voltage dip and short interruptions %UT	Duration (in period)
70	30	25P
40	60	10P
0	100	0.5P

12.3.2 Performance criterion: **C&C&C**

12.4 Test Procedure

- 1) Set up the EUT and test generator as shown on Section 13.1.2.
- 2) The interruption is introduced at selected phase angles with specified duration.
- 3) Record any degradation of performance.

13. TEST PHOTO

13.1 Photo of Radiated Emission Measurement

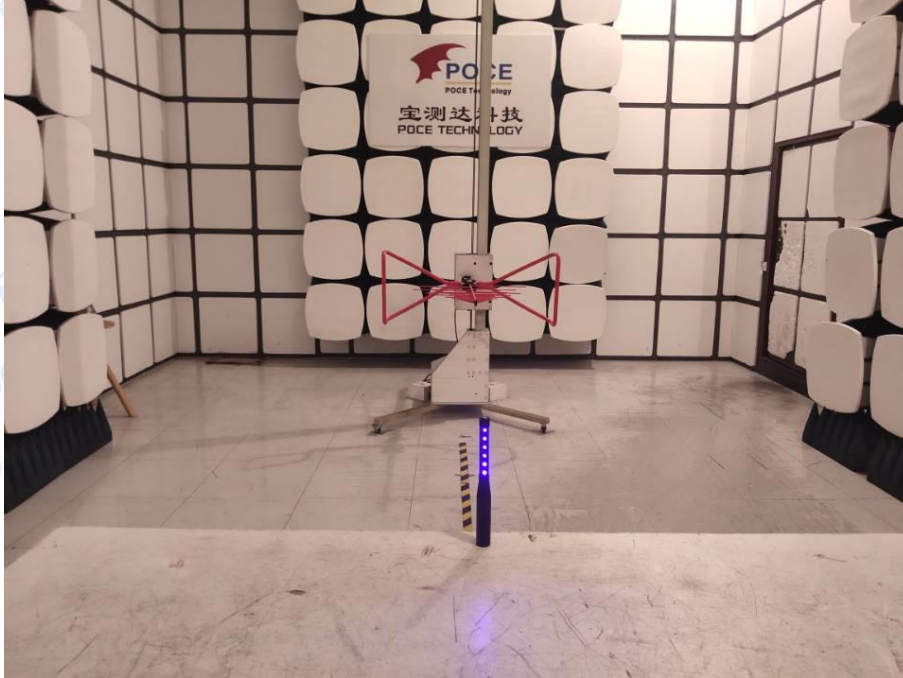

14. PHOTOGRAPHS OF EUT

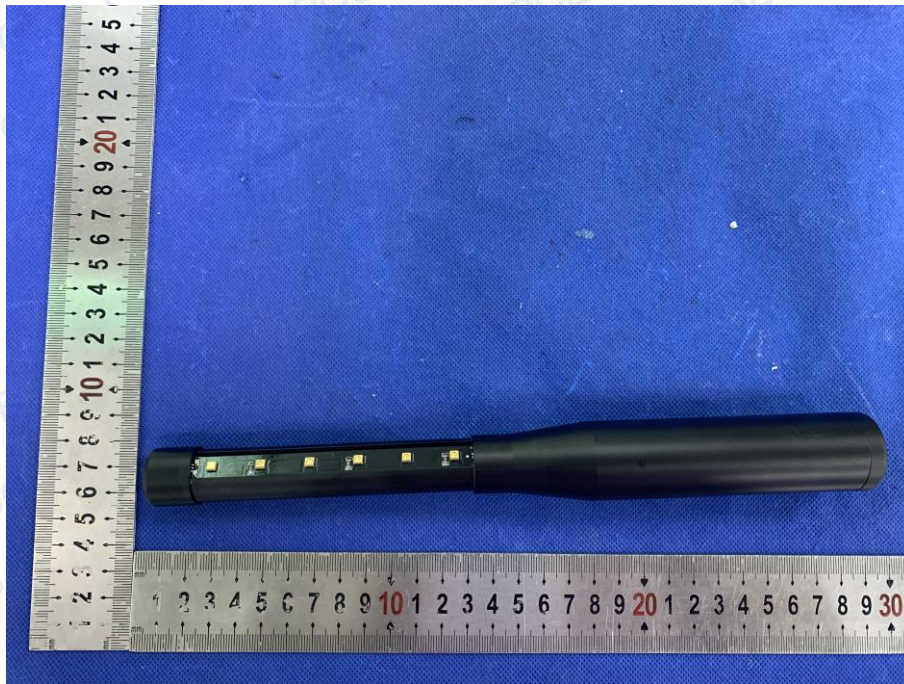

Fig.1

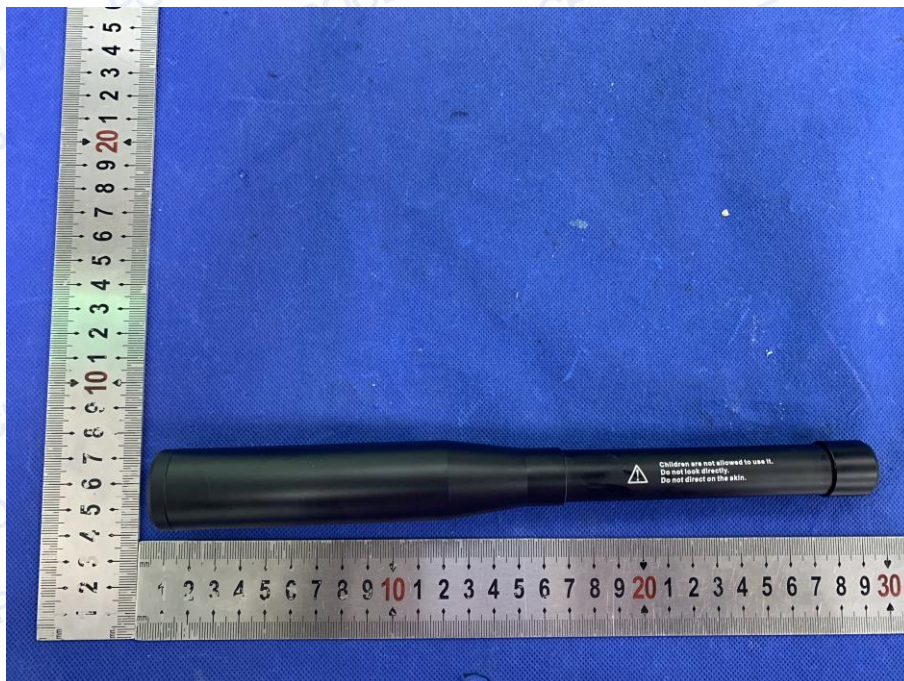

Fig.2

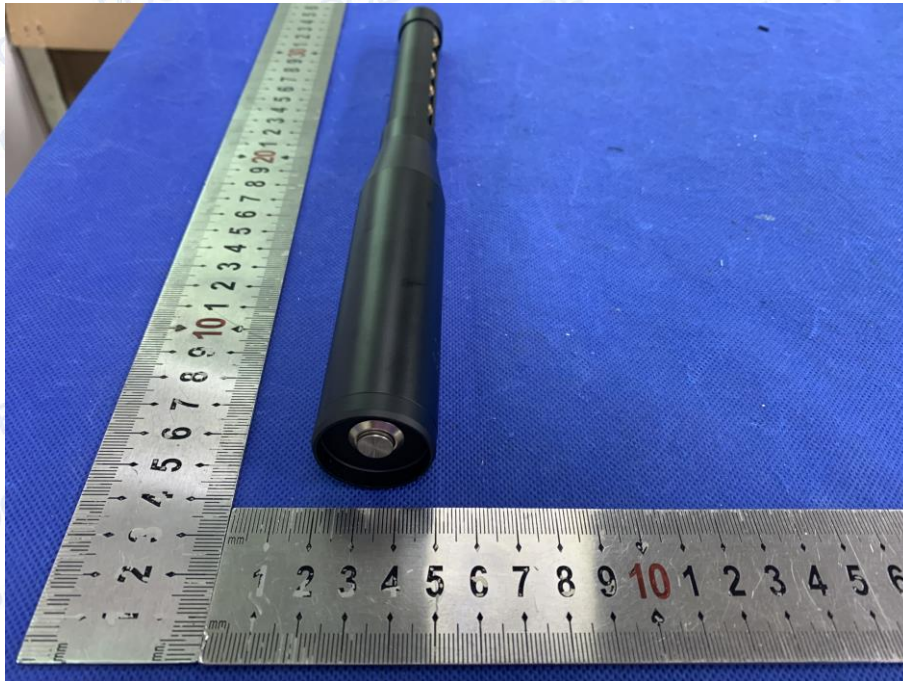

Fig.3

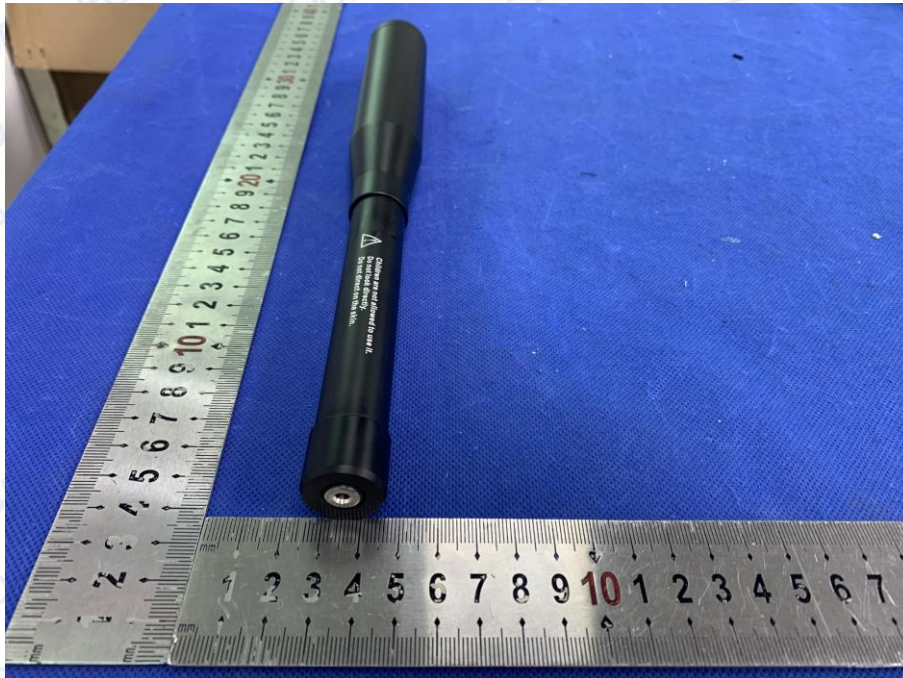

Fig.4



Fig.5

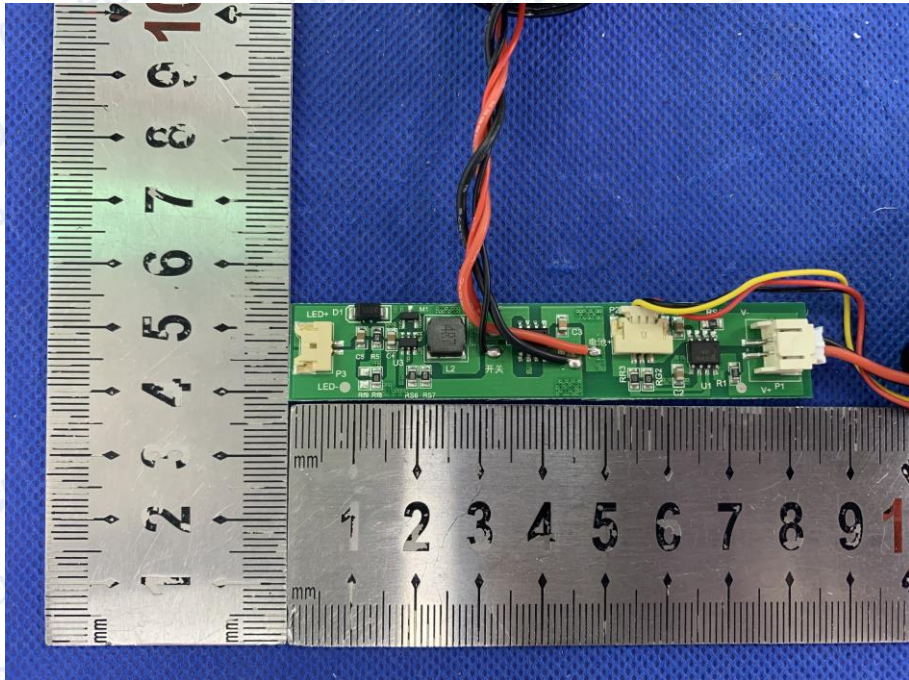

Fig.6

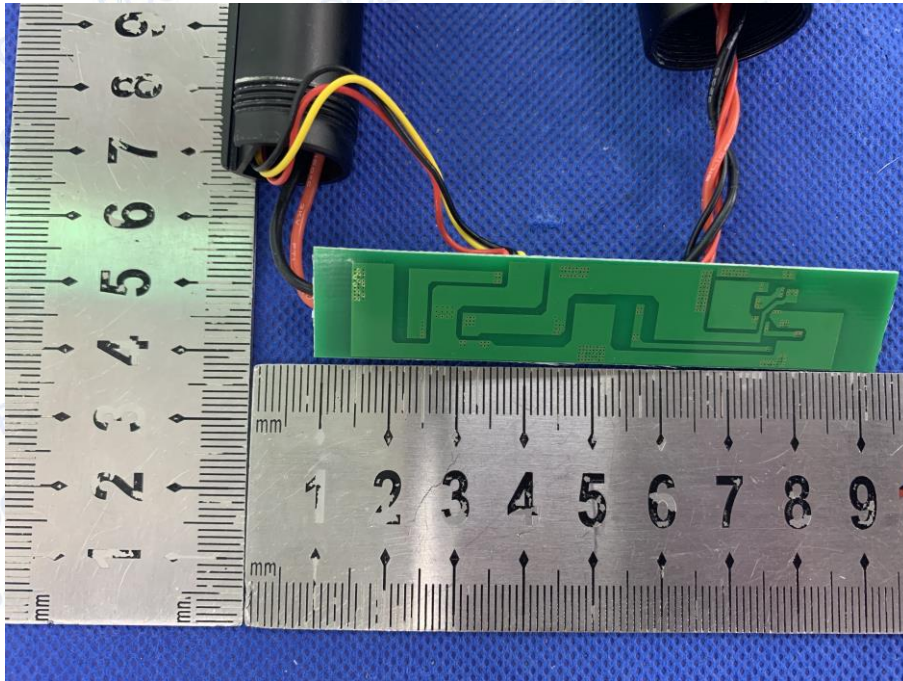

Fig.7

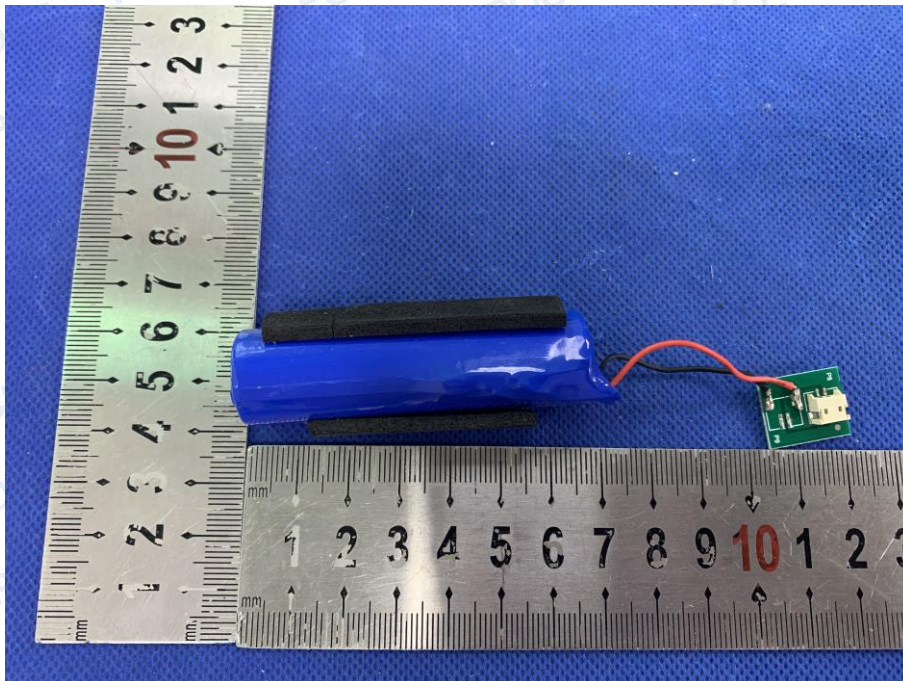

Fig.8

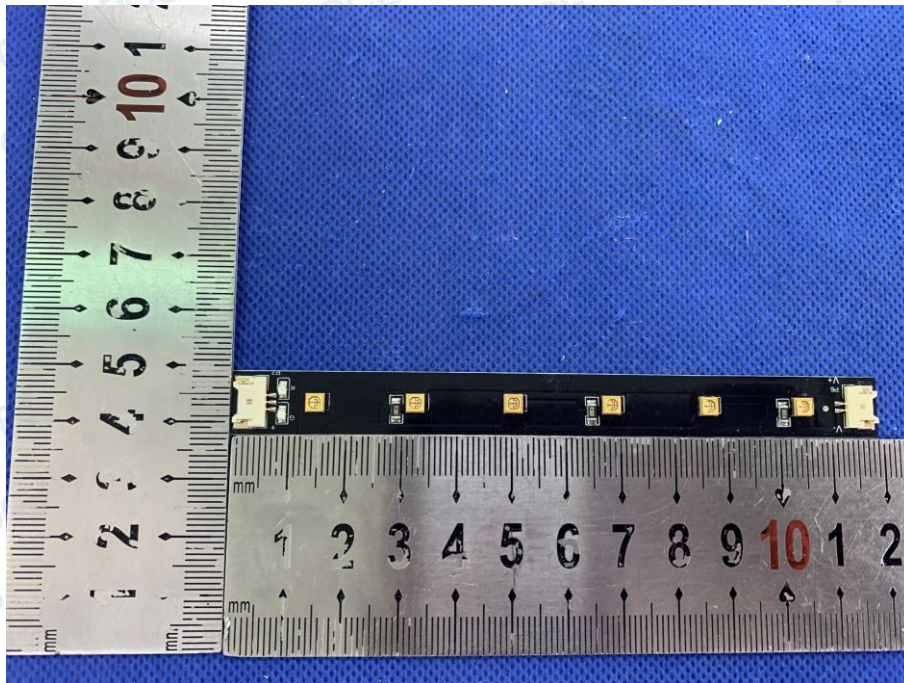

Fig.9

15. MANUFACTURER/ APPROVAL HOLDER DECLARATION

The following identical model(s):

VT-3214

Note: Model name only use for marking.

Belong to the tested device:

Product description	:	LED Ultraviolet Disinfection Lamp
Model name	:	VT-3214

Remark: So no additional models tested.

*******THE END OF REPORT*******