

**INSTALLATION INSTRUCTION**

WIFI WALL SOCKET - EU

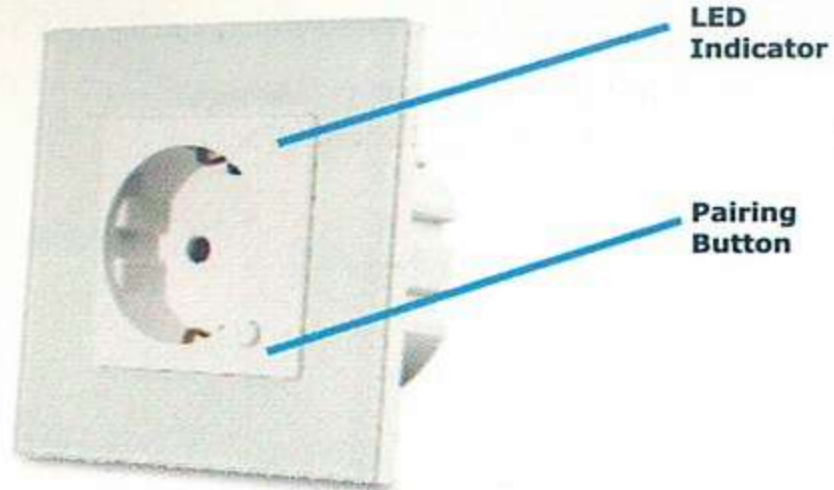

**INTRODUCTION & WARRANTY**

Thank you for selecting and buying V-TAC Product. V-TAC will serve you the best. Please read these instructions carefully before starting the installation and keep this manual handy for future reference. If you have any other query, please contact our dealer or local vendor from whom you have purchased the product. They are trained and ready to serve you at the best.

The warranty is valid for 2 years from the date of purchase. The warranty does not apply to damage caused by incorrect installation or abnormal wear and tear. The company gives no warranty against damage to any surface due to incorrect removal and installation of the product. This product is warranted for manufacturing defects only.

**SPECIFICATIONS**

Model Number	SKU	Input Voltage	Max Current	Wireless Standard	Material
VT-5134	8797	AC:90-250V	10A	Wi-Fi 2.4Ghz	PC
VT-5134	8798	AC:90-250V	10A	Wi-Fi 2.4Ghz	PC

**INSTALLATION**

**V-TAC SMART HOME APP:** Download V-TAC SMART HOME APP by going to APP Store or Google Play Store (OR)  
Download the VTAC SMART HOME APP by scanning the below QR Code



GOOGLE PLAY



IOS



FAQ



Multi-Language Manual

Note: For troubleshooting please scan the Barcode of FAQ and to read the instruction manual in a different language please scan the barcode of Multi-Language Manual

**Wiring**

**Wiring Installation:**

- 1) Cut Off the Power.
- 2) Connect the wires correctly
- 3) Install and power it up

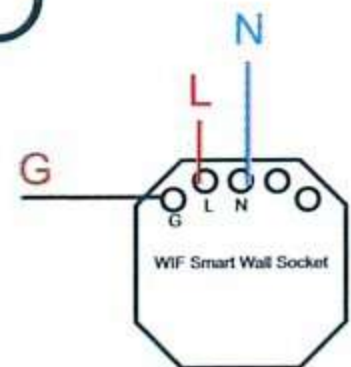

EU Wall Socket

Step1: Open the V-TAC Smart Home App and register. If you already have an existing account with V-TAC Smart Home, please proceed to logging in.



Please select a region

Phone number or email address

Password

Login

Reset Password

Register

Step3: Make sure your Smart Device is Powered.

1) Tap and Hold on the Power Button for 5 seconds to make the device available in Pairing Mode. Once in pairing mode the LED will start blinking 3 times repeatedly.

2) Tap on Next to start the pairing of device with the app. (Shown in the image)

Note: If you are facing any trouble while pairing in Quick Pairing mode please try to pair the device in Compatible Pairing Mode (Click on the link as shown on the image).

Step2: To Add a New device tap on the "+" sign(as shown)



There are no devices paired. Tap the add device button below to begin pairing devices



Quick Pairing Mode (Touch)

Power up the model, then press and hold pairing button for 5s until the led indicator blinks twice and on repeatedly. For LED or humidifier, please repeatedly turn on and off the model for 3 times, the time-gap is 2s. The led indicator will blink quickly

Compatible Pairing Mode (AP)

Next

Step4: Select your Wifi Name and enter the password and Tap on Next.



(Only supports 2.4G WiFi)

WiFi name: Vtac

WiFi password: [input field]

Remember password

Next

Step5: Give a Name to your Device(Ex: Smart Plug/ smart switch) & Tap on complete.



My devices

Complete

Step6: Your Device is now paired and will appear (Ex: as shown in the below image).

- a) To turn the device ON /OFF tap on the ON/OFF icon(as shown in the below image).
- b) To enter more settings of the Smart device tap on the Name



Step7: On the Deice page V-TAC SMART HOME offers multiple features as mentioned below

- a) Share - This function allows you to share the access with another user.
- b) Schedule: Schedule timer allows you to turn the device ON/OFF with flexibility of choosing date and time. This feature also allows Repeat mode using which you can set the desired configuration to daily OR any day of the week.
- c) Timer : Timer function allows you to set "day-Hour-Minute" using which you can Schedule the device to Turn ON/OFF
- d) Loop Timer - This function allows you to set a time loop for how long should the device be ON and after how long the device should be turned off.



**ALEXA SETTINGS**

Step1: Install the Amazon Alexa app via the App Store (iOS) or the Play Store (Android) and register. If you already have an existing account with Amazon Alexa, please proceed to logging in.

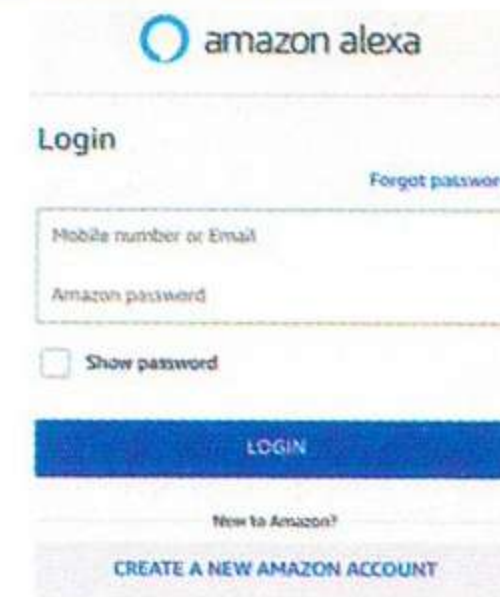

Step3: On the Home page of Amazon Alexa App, Tap on the icon as shown on the image below.



Step2: Once you are on the Amazon Alexa home page, tap on the lower right icon — where the arrow is pointed— to add a new device and Enable Skills.



Step4: Tap on "Skills & Games" as show below

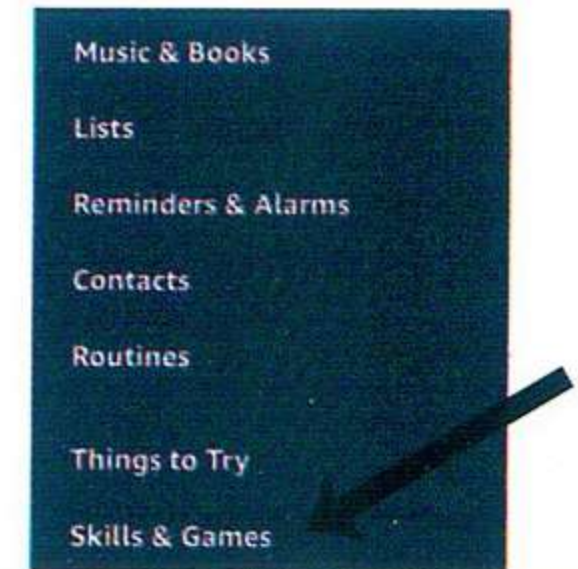

Step5: On the Search bar as shown below type "V-TAC" and tap on the V-TAC skill as shown on the image.

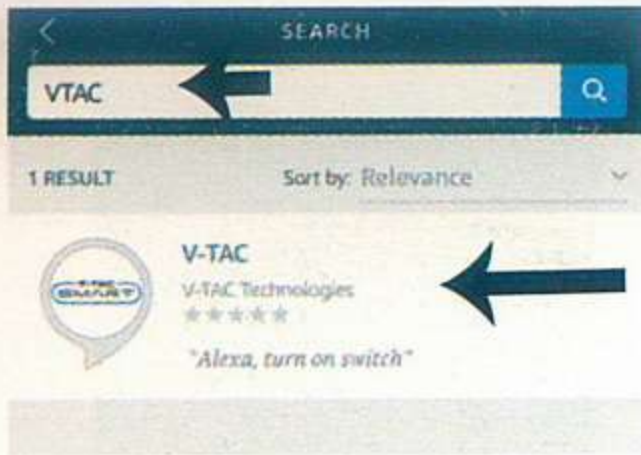

Step7: Enter Login credentials of V-TAC Smart Home and then tap on Log In. If you do not have an existing account please register by tapping on the register.

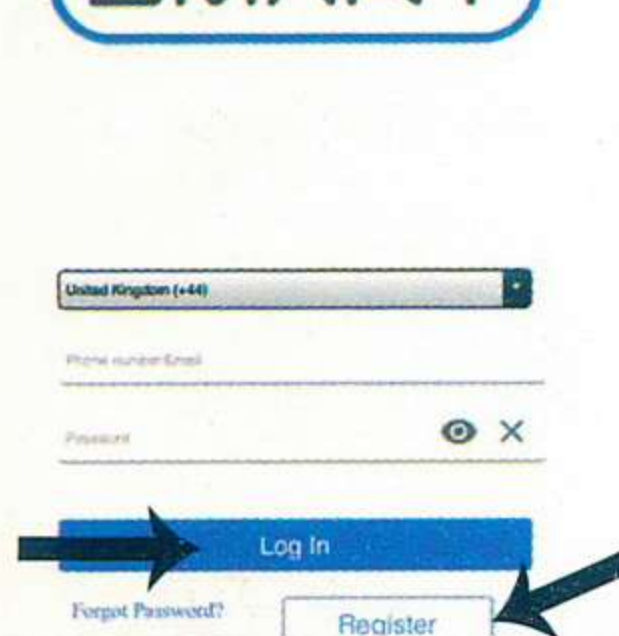

Step6: Tap on Enable Skill to link V-TAC Smart Home app with Amazon Alexa.



Step8: a) Once you have successfully linked V-TAC Skill close the window & (b) tap on Discover device. Make sure Smart device is paired with V-TAC Smart Home app.

a) **amazon alexa**



V-TAC has been successfully linked.

What to do next:

→ Close this window to discover smart-home devices you can control with Alexa.

b) Discover Devices

Smart Home devices must be discovered before they can be used with Alexa.



Step9: Discover your smart device on Alexa. You can say "Alexa discover devices" to the Alexa device which you have. (OR) you can add new devices manually by going to the home page of Amazon alexa and tapping on the icon (Ref: image A) & tap on "+" sign to add new device (Ref: Image B). Once the device is discovered you can now control your smart device using Alexa.

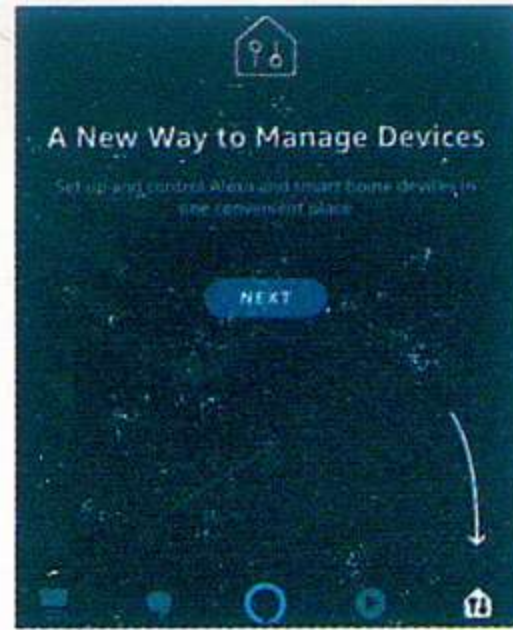

Image A



Image B

Note: Discovering the device must be done every time the device's name is changed on the app.

### ALEXA Commands

Now, you can control your smart device using voice commands on Alexa. Below is an example of commands you can use:

>! Alexa, turn ON Smart Plug

>! Alexa, turn OFF Smart Plug

### THINGS TO REMEMBER BEFORE STARTING INSTALLATION:

1. V-TAC Smart Home App & Amazon Alexa App
2. Make sure you have Amazon Alexa Device (including Echo, Echo Tap, or Echo Dot)
3. Smart Home Device
4. Stable Wifi network

### GOOGLE HOME SETTINGS

Step1:

- a&b) Install the Google Home app via the App Store (iOS) or the Play Store (Android) and register. If you already have an existing account with Google Home, please proceed to logging in.
- c) Create a New Home/Choose from the existing home if any.
- d) Power ON the Google Home device and connect it to the App. (Then Proceed to step 2)

a. Welcome home

Your content and devices all in one place



b. Choose account

This account will be used to personalize your experience

d. Plug in your device

Make sure your device is nearby and connected to power, then try again



c. Choose a home

You will be able to control the devices and services in this home.

+ Create another home

GET STARTED >

Step2: Once you are on the Google home page, tap on the Add "+" icon— to add a new device and skill. And then tap on Set up device as shown in below image.

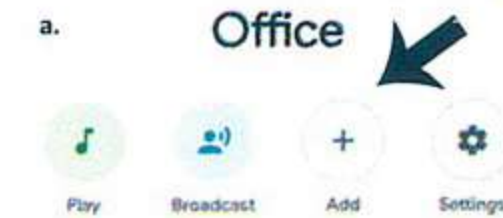

Office  
1 device



b. Add to Home

- + Set up device
- + Add home member
- + Create speaker group
- + Create new home
- Add services
- + Music and audio
- + Videos and photos

Step3: Make sure the Smart Device is paired with V-TAC Smart Home app before starting step 3. Tap on the arrow section as highlighted in the below image.

Step4: Type "Vtac" on the search bar and tap on the icon from the drop down options of VTA Smart as shown below.

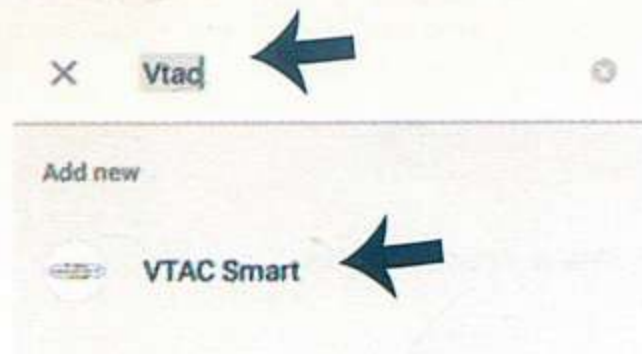
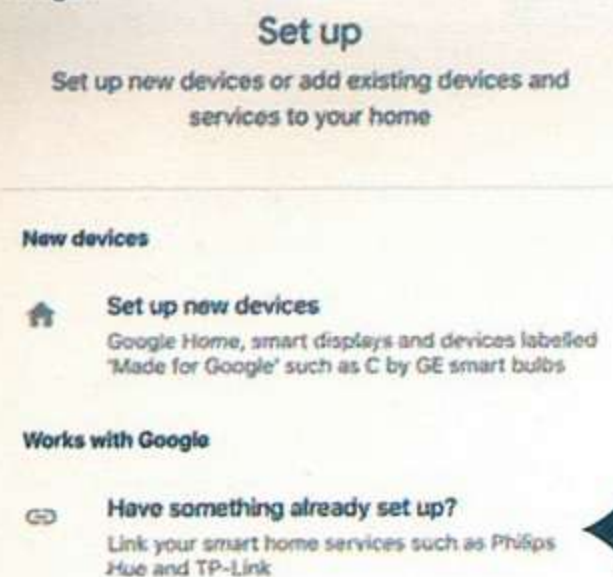

Step5: Sign In with your V-TAC Smart Home Login credentials to Link the Smart Home device

Step6:  
a. Account will now be linked, please stay on the page you will be redirected in few seconds to select the device to add to your home.  
b. Select the device and tap on Next as show in image(b)

a. Done [assistant.google.com](https://assistant.google.com)  
Account is now Linked  
b. X Choose device



Step7: Select the Home where you would like to add the Smart Device under. (Or) you can create a New home in order to add the Smart Device to it.

Step8: You have successfully added V-TAC Smart device to your Google home App.

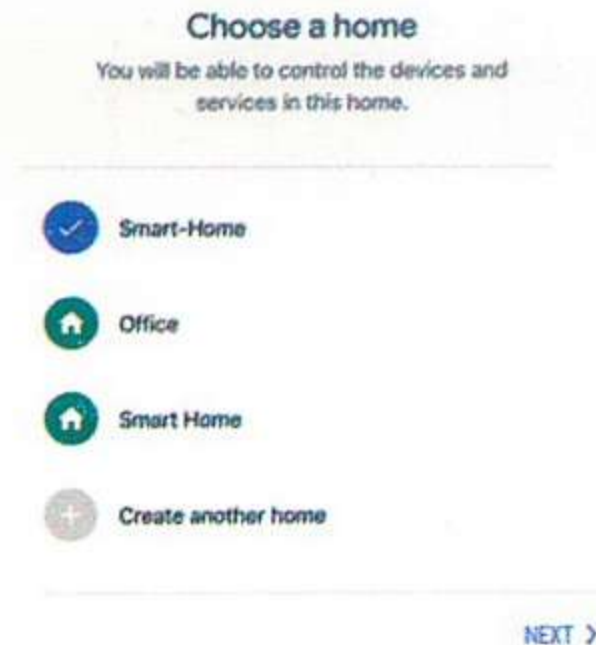

Step9: You can turn the Device On/OFF by taping On/Off options as shown below. (OR) You can tap on the Name(Ex:Smart Plug as shown below) to redirect to new page.



**Google Commands:**

Now, you can control your smart device using voice commands on Google Home. Below are a few example commands you can use:

- >! OK Google, turn ON Smart Plug
- >! OK Google, turn OFF Smart Plug

**THINGS TO REMEMBER BEFORE STARTING INSTALLATION:**

1. V-TAC Smart Home App & Google Home App
2. Make sure you have Google Home Device
3. Smart Home Device
4. Stable Wifi network